

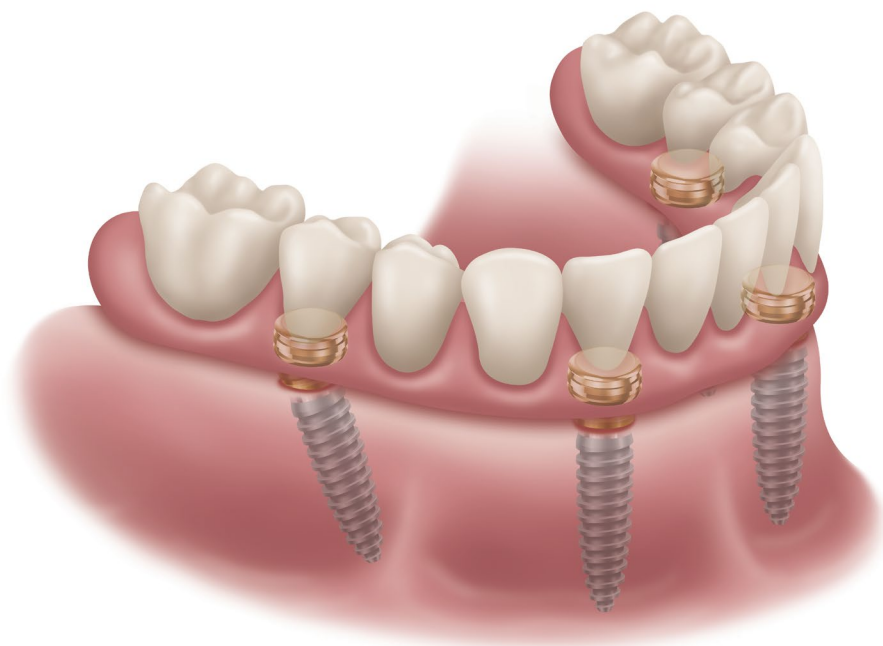

LOCATOR FIXED[®]



LOCATOR FIXED[®] PROSTHETIC AND LAB PROCEDURES

TABLE OF CONTENTS

INTRODUCTION TO LOCATOR FIXED®	3
IDENTIFYING CANDIDATES FOR LOCATOR FIXED®	4
CLINICAL REQUIREMENTS	5
A. PROSTHETIC (RESTORATIVE) SPACE	5
B. IMPLANT PLACEMENT	6
C. IMPLANT ANGULATION	6
D. LOCATOR® FOR MULTI UNIT ABUTMENTS	7
E. A/P SPREAD AND CANTILEVER	7
LOCATOR FIXED® MATERIAL OPTIONS	8
MATERIAL OPTIONS MATRIX	9
RECORDS CAPTURE	10
A. TRADITIONAL	11
B. DIGITAL	14
PROSTHETIC FABRICATION	25
A. ANALOG TECHNIQUES	25
B. DIGITAL TECHNIQUES	29
HOUSING PICK-UP	31
A. CEMENTATION/BONDING CONSIDERATIONS	32
B. LAB PICK-UP	33
C. CHAIRSIDE PICK-UP-NEW PROSTHESIS OR IMMEDIATE CONVERSION	35
PROSTHESIS SEATING AND REMOVAL	40
A. SEATING AND REMOVAL TOOL	40
B. SEATING	41
C. REMOVAL	44
AFTER-CARE	45
PRESCRIPTION WRITING TIPS	46
TROUBLESHOOTING GUIDE	47

INTRODUCTION TO LOCATOR FIXED: THE BEST OPTION IN FIXED PROSTHETICS

LOCATOR FIXED: THE BEST OPTION IN FIXED PROSTHETICS

Zest LOCATOR FIXED® delivers a fixed full-arch solution using the universally respected LOCATOR abutment and its clinician-friendly pick-up process. Compared to traditional screw-retained offerings, LOCATOR FIXED is a simpler, quicker, and more cost-effective solution to restore your edentulous patients' self-confidence, self-esteem, and overall quality of life.

The unique design of LOCATOR FIXED eliminates the need for screws and screw access channels, which reduces the required prosthetic space and allows clinicians to minimize surgical invasiveness, simplify both clinical and technical procedures, and complete the process in less time with fewer patient visits. And, since the prosthesis can be removed and seated in seconds, your patient will enjoy shorter follow-up and hygiene appointments.

Additionally, LOCATOR FIXED allows existing LOCATOR patients to more easily step up from a removable to a fixed solution without changing abutments or being burdened by the high cost of traditional screw retained prostheses.

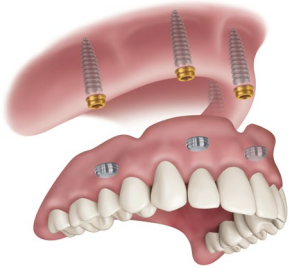
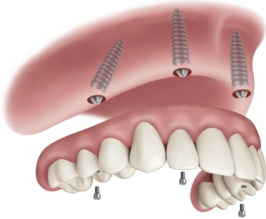
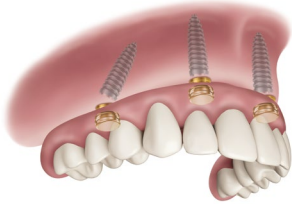
Traditional Denture	4 Implant Overdenture	Screw Retained (Fixed)	LOCATOR Fixed
			
POOR	BETTER	OLD BEST (Not Accessible \$\$)	NEW BEST

IDENTIFYING CANDIDATES FOR LOCATOR FIXED®

LOCATOR FIXED is appropriate for both single arch and dual-arch cases, where the minimum clinical requirements in the following section are met. LOCATOR FIXED prosthetics can be manufactured using a wide variety of materials, and LOCATOR FIXED cases can be started from any phase of the patient's treatment journey: from partially edentulous to existing implants.

PATIENTS WITH EXISTING LOCATOR® OR IMPLANTS:

Existing LOCATORs/implants can be utilized in a new LOCATOR FIXED case provided the implants meet the criteria in the implant placement section on page 6. Abutments should be checked for wear. If there are any signs of wear the abutment should be replaced.

VARIOUS PATHWAYS FOR LOCATOR FIXED TREATMENT

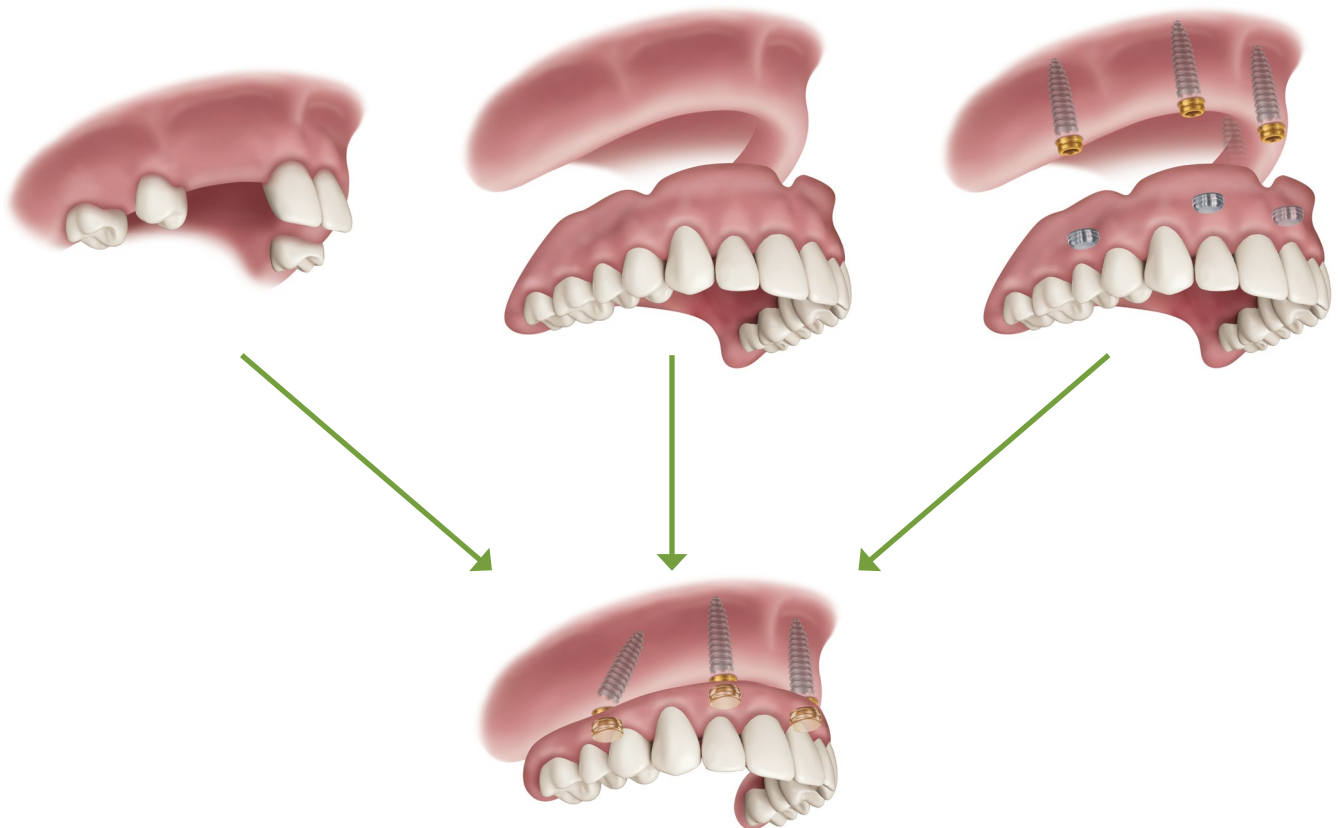

CLINICAL REQUIREMENTS

PROSTHETIC/RESTORATIVE SPACE REQUIREMENTS

Prosthetic height is measured from the edentulous ridge to the most superior portion of the prosthesis, most often the incisal edge or occlusal surface of the restoration. In cases where the incisal edge is positioned facially or lingually/palatal, the measurement is made from the ridge to the portion of the lingual/palatal prosthesis positioned above the implant platform.

Restorative space is typically calculated by adding the prosthetic height to the measured tissue depth from the implant platform to the edentulous ridge. If the tissue depth is unknown, an estimate of 2mm tissue depth for mandibular cases and 3mm tissue depth for maxillary cases are appropriate averages for use in calculating restorative space.

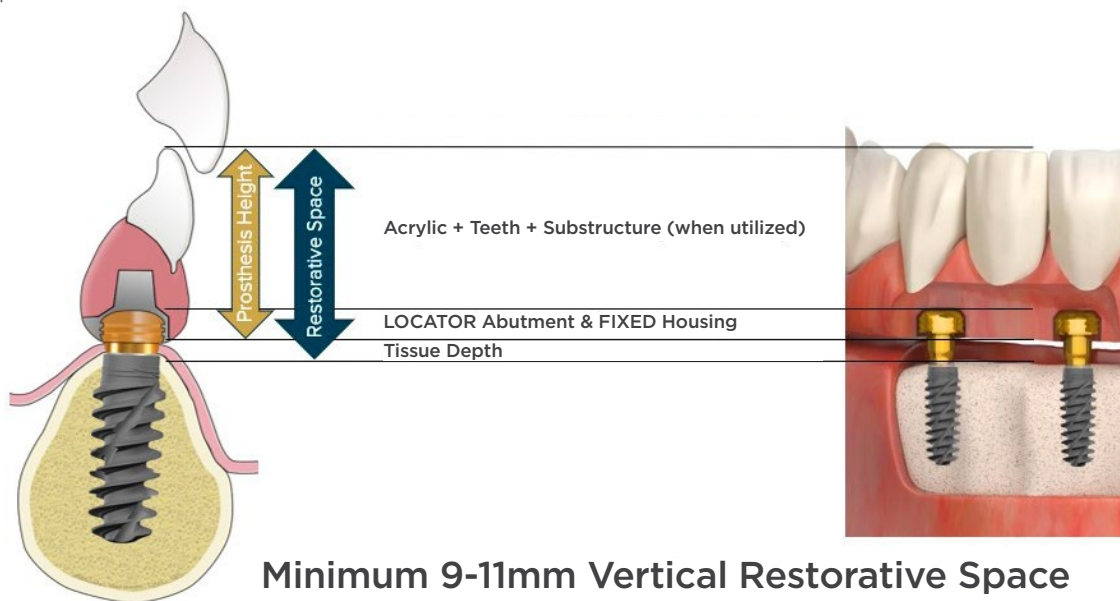

Minimum 9-11mm Vertical Restorative Space

Depending on the restorative material selected, LOCATOR FIXED prostheses require 9-11mm of vertical prosthetic space. In cases where Multi-unit Abutments are used, an additional 3mm of vertical prosthetic space is required.

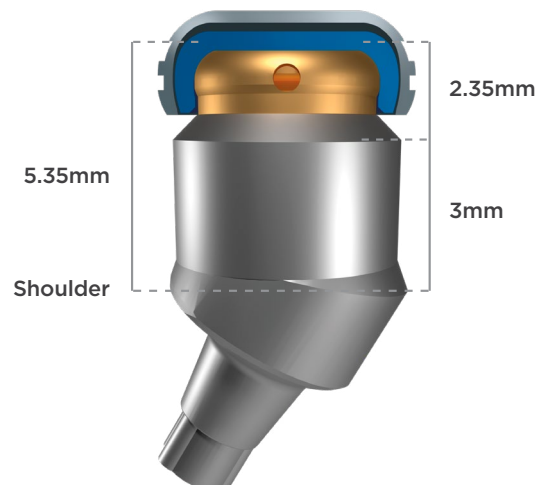

CLINICAL REQUIREMENTS (CONTINUED)

IMPLANT PLACEMENT

A minimum of 4 implants are required for successful treatment with LOCATOR FIXED®. Implants should be placed as symmetrically as possible and the posterior-most implants should be placed as posteriorly as possible. Cross arch stabilization is required.

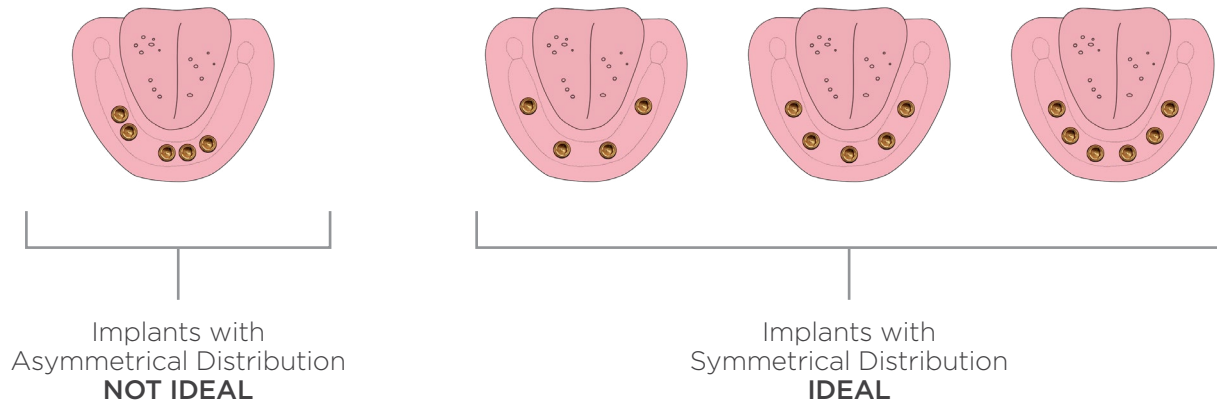

IMPLANT ANGULATION

LOCATOR FIXED® offers angulation correction of up to 20 degrees per implant or up to 40 degrees of total angulation between any two implants. The simplest way to measure angulation is to engage a manual driver into the healing abutment or dental implant platform and then use the Zest Angle Measurement Guide (09530-SB). The measured angulation between each set of implants should not exceed 40 degrees total (or 20 degrees per implant).

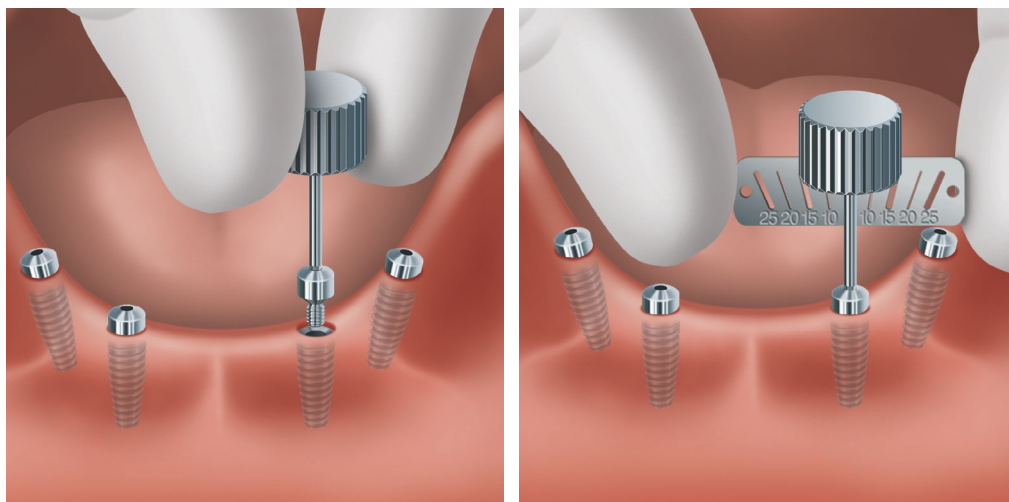

CLINICAL REQUIREMENTS (CONTINUED)

LOCATOR® FOR MULTI-UNIT ABUTMENTS

The LOCATOR for MUA features a two-piece component made up of a sleeve that fits over the outside of the multi-unit abutment and is held in place by the LOCATOR abutment that threads into the multi-unit screw-channel. This option allows for additional angle correction outside of the 20 degrees per implant in either direction.

The LOCATOR Multi-Unit abutment requires an additional 3mm of additional vertical Prosthetic space to accommodate the multi-unit abutment hardware. Clinicians and technicians should consider choosing the lowest height multi-unit abutment possible and placing implants slightly deeper if anticipating using LOCATOR Multi-Unit for LOCATOR FIXED.

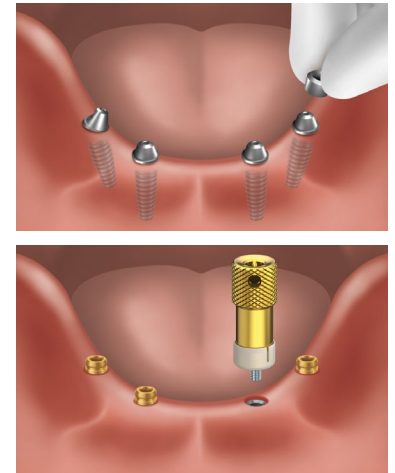

A-P SPREAD AND CANTILEVER (The distance between implant fixtures in the anterior-posterior dimension)

Regardless of the number of implants used, the recommended cantilever for all material types is no more than 1X A/P spread. In cases where patient bruxism is a concern, the cantilever should never be greater than .5X the A/P spread.

Prostheses that do not have a support substructure, and are made from any material other than zirconia, should not have a cantilever. However, a 2mm extension past the posterior-most implant should be incorporated into the prosthesis to facilitate the use of the removal tool.

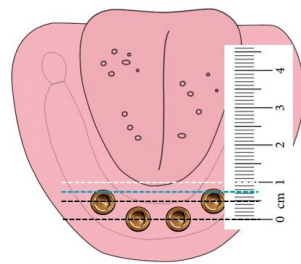

5mm AP Spread
0.5x AP - Green Line
1.0x AP - White Line

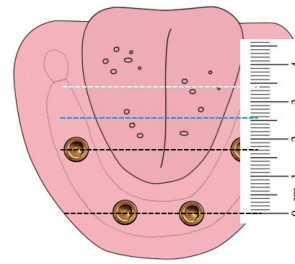

17mm AP Spread
0.5x AP - Green Line
1.0x AP - White Line

LOCATOR FIXED® MATERIAL OPTIONS

A wide variety of materials are suitable for LOCATOR FIXED Prostheses. Monolithic zirconia and substructure-strengthened restorations demonstrate the highest fracture resistance, allow for the longest cantilevers, and require the least amount of prosthetic space. However, monolithic digitally produced printed or milled materials have also shown clinical success provided the minimum thicknesses identified in the following section on page 9 are met.

MATERIAL OPTIONS BY TYPE, STRENGTH AND COST

PMMA/RESIN TOOTH & BASE COMBINATION



METAL FRAMEWORK SUPPORTED PROSTHESIS

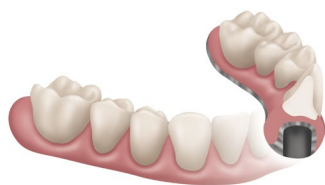

SUBSTRUCTURE & OVERLAY PROSTHESIS



Milled Monolithic PMMA Teeth & Base with Layered Pink Composite
STRENGTH: MEDIUM
COST: \$



3-D Printed Titanium with Monolithic Overlay (AvaMax)
STRENGTH: HIGH
COST: \$\$



Polymer Bar with Milled Polymer Teeth with Layered Composite
STRENGTH: HIGH
COST: \$\$



Photopolymer Resin (3-D printed)
STRENGTH: MEDIUM
COST: \$



CoCr Frame with processed denture teeth & PMMA
STRENGTH: HIGH
COST: \$\$\$



Monolithic Zirconia
STRENGTH: HIGHEST
COST: \$\$\$\$

LOCATOR FIXED[®] MATERIAL OPTIONS MATRIX

CLINICAL & LABORATORY RECOMMENDATIONS

Prosthetic Material	Recommended Minimum Prosthesis Height / Vertical Restorative Space [‡]	Recommended Minimum Prosthesis Thickness Around Housing	Recommended Maximum Cantilever*
Conventional Resin Prosthesis Analog Processed Denture Teeth with Ti/CoCr Substructure	Prosthesis Height: ≥8mm Restorative Space: ≥10mm	≥4mm	1.0x A/P Spread
Monolithic Resin Prosthesis Analog Processed Acrylic Resin	Prosthesis Height: ≥11mm Restorative Space: ≥13mm	≥5mm	2mm Beyond Final Implant to Accommodate the Removal Tool Loop
Monolithic Resin Prosthesis Digital Processed Photopolymer	Prosthesis Height: ≥11mm Restorative Space: ≥13mm	≥5mm	2mm Beyond Final Implant to Accommodate the Removal Tool Loop
OnX Tough 2 Monolithic Nanoceramic Resin Prosthesis Digital Processed Photopolymer	Prosthesis Height: ≥8mm Restorative Space: ≥10mm	≥4mm	0.5x A/P Spread
AvaMax Monolithic Acrylic Resin Prosthesis with Metal Substructure with Titanium Substructure	Prosthesis Height: ≥9mm Restorative Space: ≥11mm	≥3mm	1.0x A/P Spread
Monolithic Nano-Ceramic / Composite-Resin Prosthesis without a Substructure	Prosthesis Height: ≥9mm Restorative Space: ≥11mm	≥5mm	2mm Beyond Final Implant to Accommodate the Removal Tool Loop
Nano-Ceramic / Composite-Resin Prosthesis with Fiber Composite Substructure	Prosthesis Height: ≥8mm Restorative Space: ≥10mm	≥4mm	0.5x A/P Spread
Nano-Ceramic / Composite-Resin Prosthesis with Reinforcing Substructure	Prosthesis Height: ≥8mm Restorative Space: ≥10mm	≥3mm	1.0x A/P Spread
Zirconia Prosthesis without Ti/CoCr Substructure	Prosthesis Height: ≥8mm Restorative Space: ≥10mm	≥5mm	1.0x A/P Spread
Zirconia Prosthesis with Ti/CoCr Substructure	Prosthesis Height: ≥7mm Restorative Space: ≥9mm	≥3mm	1.0x A/P Spread

[‡]Recommended vertical restorative space as measured from the implant platform to the incisal edge / cameo surface of the prosthesis.

*Zest Dental Solutions data on file. Cantilever based upon A/P spread are maximum values in does not mean the prosthesis cantilever should be set to those values as a "baseline".



LEARN MORE ABOUT THESE RECOMMENDATIONS
OR VISIT [HTTPS://ZEST.PUB/WHITEPAPER](https://zest.pub/whitepaper)

RECORDS CAPTURE: TRADITIONAL AND DIGITAL

The following components are recommended for impression taking:

- **LOCATOR® Abutments**
- **LOCATOR® Enhanced Core Tool (08340-M)**
- **LOCATOR® Impression Copings (08505-SB)**
- **LOCATOR® Female Analogs (08530-SB)**
- **LOCATOR® Abutment Manual Driver with Abutment Holder (08536-SB)**
- **LOCATOR® Square Driver Torque Wrench Insert (08926-SB)**
- **.050" (1.25mm) Hex Driver with Thumb Knob (08007-SB)**
- **Torque Indicating Ratchet Wrench (07362-M)**
- **LOCATOR CHAIRSIDE Light Body Impression Material (09614-M)**
- **LOCATOR CHAIRSIDE Heavy Body Impression Material (09616-M)**

LOCATOR
Abutment



LOCATOR Systems Enhanced Core Tool
08340-M



Impression Coping
08505-SB



LOCATOR Female Analogs
08530-SB



LOCATOR® Abutment Manual Driver with
Abutment Holder
08536-SB



LOCATOR® Square Driver Torque Wrench Insert
08926-SB



.050" (1.25mm) Hex Driver with Thumb Knob
08007-SB



Torque Indicating Ratchet Wrench
07632-M



LOCATOR CHAIRSIDE Light Body
Impression Material
09614-M



LOCATOR CHAIRSIDE Heavy Body
Impression Material
09616-M



RECORDS CAPTURE: ANALOG IMPRESSION

Capturing an accurate impression is critical to the successful fabrication of a well-fitting final prosthesis. For best results, traditional impression materials used in conjunction with closed or custom trays are recommended. The following steps, including options for improving impression accuracy, should be closely adhered to.

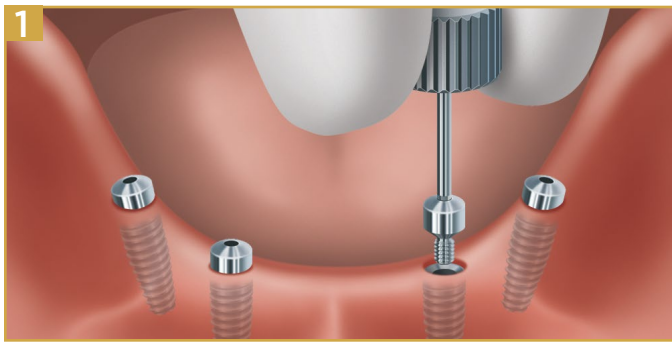

1 If present, remove healing abutments.

NOTE: If existing LOCATOR® abutments are already present, inspect them for wear and correct cuff height. If debris is present, clean abutments prior to step 4.

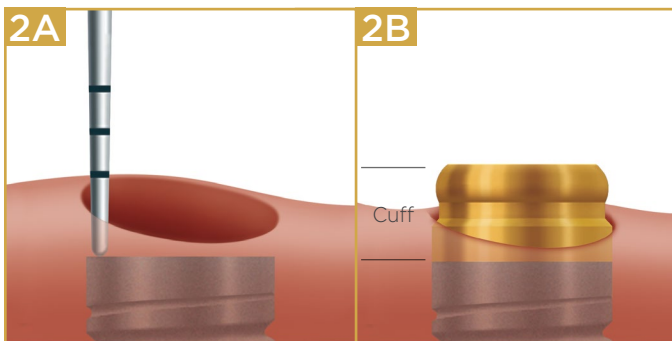

2A-2B Measure tissue height for each implant site and select the corresponding LOCATOR® abutment.

NOTE: If the tissue depth is 2mm, select the 2mm LOCATOR® abutment. Choose the higher cuff height if the measurement is between depths for LOCATOR FIXED.

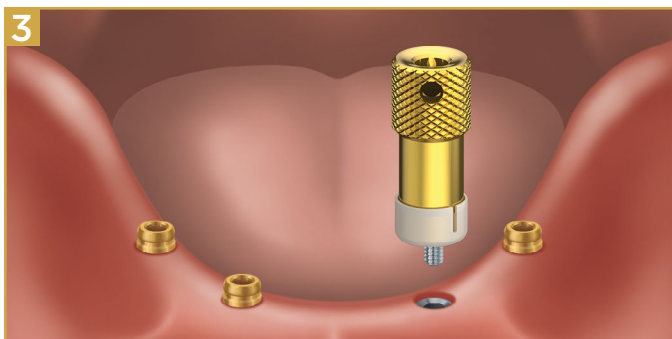

3 Hand tighten the LOCATOR Abutment into the implant.

NOTE: Make a radiograph to confirm the Abutments are fully seated onto the implants.

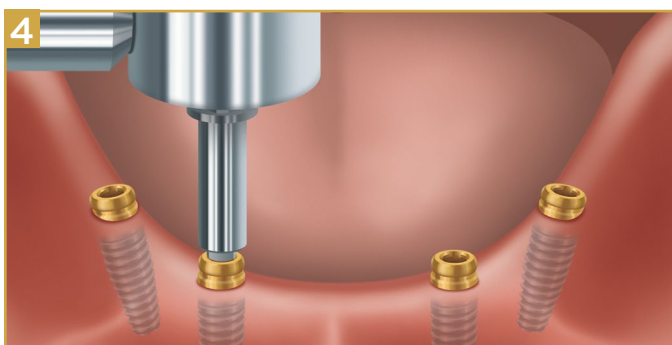

4 Using a torque device and the LOCATOR Driver Insert, torque each LOCATOR Abutment to 30Ncm or to the recommended torque from the implant manufacturer.

NOTE: Implants with $\leq 1.4\text{mm}$ thread require the LOCATOR Abutment be torqued to 20Ncm.

WARNING: Use of higher torque values than recommended could cause a fracture of the LOCATOR Abutment.

RECORDS CAPTURE: ANALOG IMPRESSION (CONTINUED)

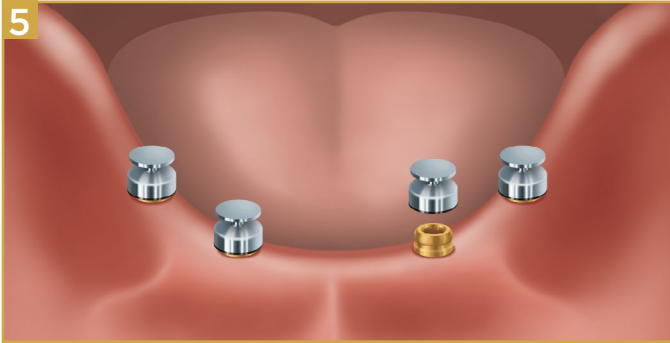

5 Place impressions copings.

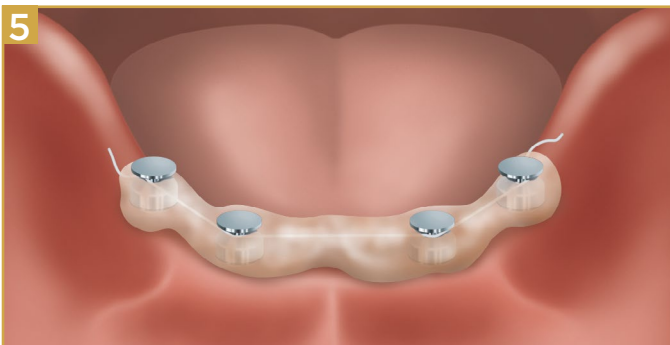

5 **OPTIONAL** Splint the impression copings together using dental floss and acrylic or composite resin for a more accurate master cast.

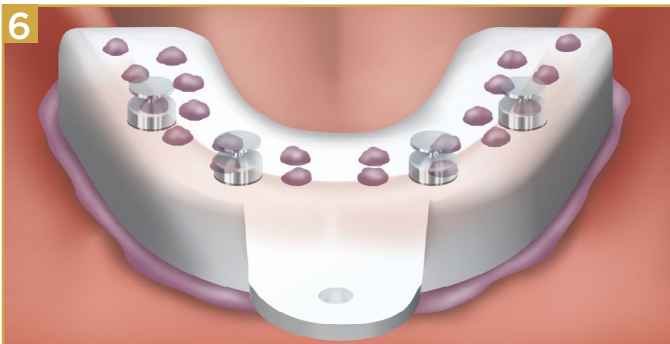

6 Choose either a plastic stock tray or a custom tray for taking the impression.

**Zest recommends using a closed tray technique.*

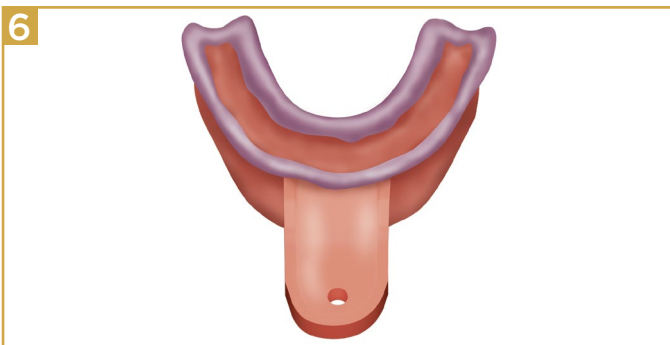

6 **OPTIONAL** Using a custom tray and border molding is recommended in order to maximize the capture of the prosthetic borders.

Use a heavy body material or compound material for initial border capture.

RECORDS CAPTURE: ANALOG IMPRESSION (CONTINUED)

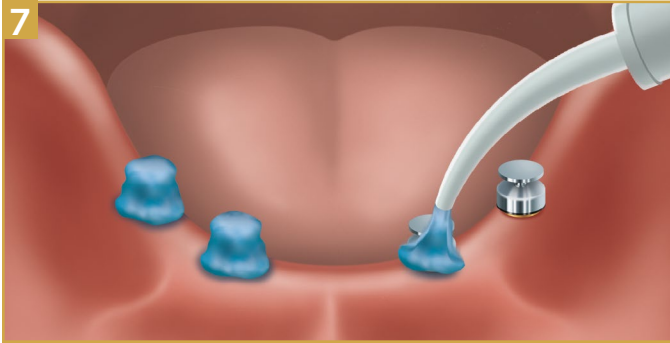

7 Using traditional impression material, apply an initial coating (light body material) to the impression copings for best results.

Use heavy body impression material for the remainder of the impression.

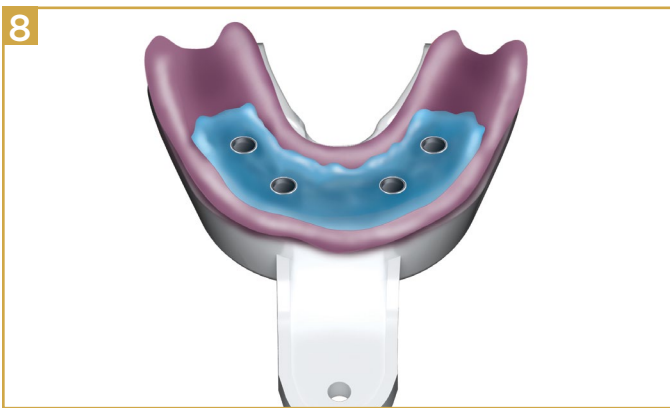

8 Evaluate the final impression to ensure accurate capture of all impression copings.

RECORDS CAPTURE: DIGITAL

There are three primary methods for digital impressioning:

1. Intraoral scanning with LOCATOR® Abutments and Scan Bodies placed onto each Abutment.
2. A reference denture scan in addition to intraoral scanning with LOCATOR Abutments and Scan Bodies placed.
3. Digitization of traditional plaster casts made from traditional record capture.

DIGITAL METHOD 1: SCANNING WITH LOCATOR® ABUTMENTS AND SCAN BODIES PLACED.

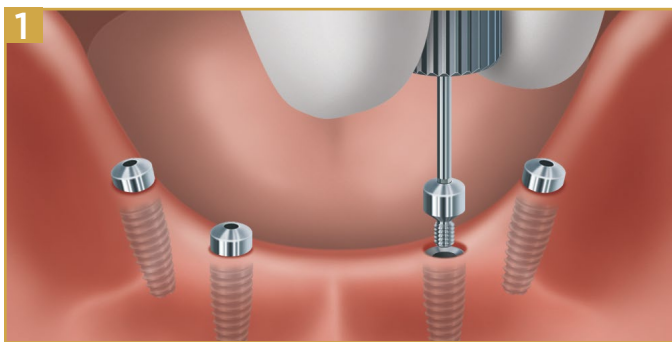

1 If present, remove healing abutments.

NOTE: If existing LOCATOR® abutments are already present, inspect them for wear and correct cuff height. If debris is present, clean abutments prior to step 4.

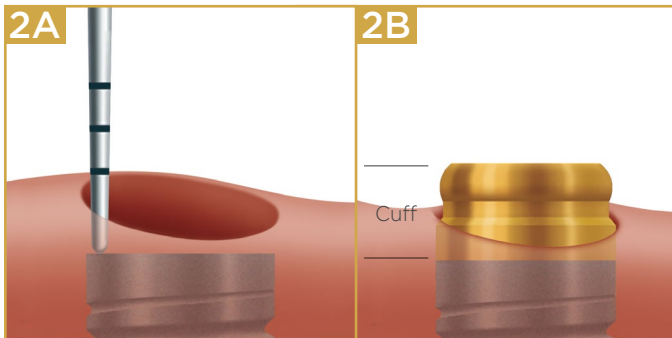

2A-2B Measure tissue height for each implant site and select the corresponding LOCATOR® abutment..

EXAMPLE: If the tissue depth is 2mm, select the 2mm LOCATOR® abutment. Choose the higher number if the measurement is between depths.

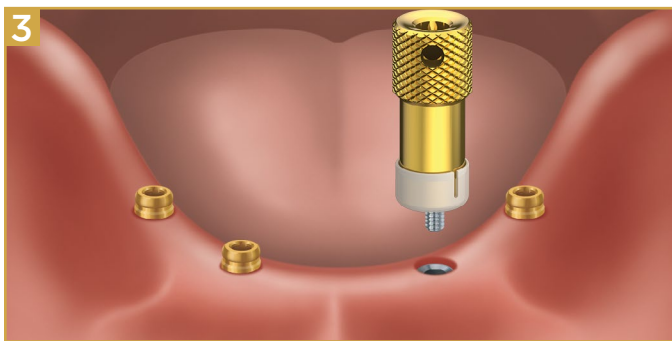

3 Hand tighten the LOCATOR Abutment into the implant.

NOTE: Make a radiograph to confirm the Abutments are fully seated onto the implants.

DIGITAL RECORD CAPTURE: METHOD 1

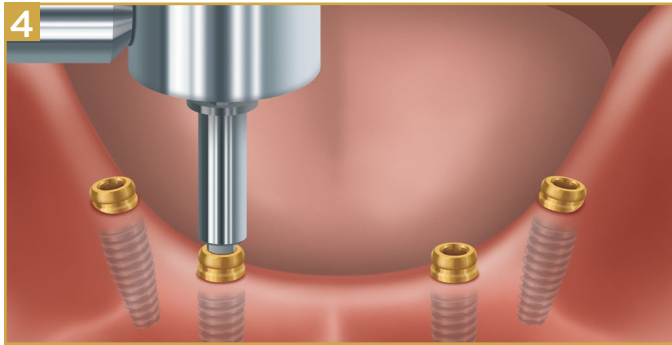

4 Using a torque device and the LOCATOR Driver Insert, torque each LOCATOR Abutment to 30Ncm or tighten to the recommended torque from the implant manufacturer.

NOTE: Implants with $\leq 1.4\text{mm}$ thread require the LOCATOR Abutment be torqued to 20Ncm.

WARNING: Use of higher torque values than recommended could cause a fracture of the LOCATOR Abutment.

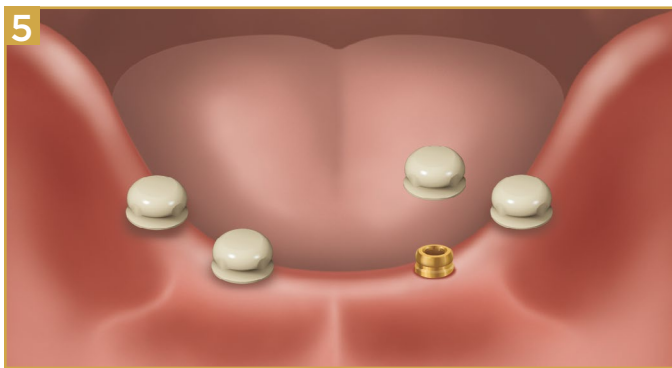

5 Place LOCATOR® scan bodies on the abutments.

NOTE: If gold is showing under the scan body, this is a sign your abutments are too tall and can cause issues with capturing accurate scans.

TIP: Some scanners have more difficulty scanning metallic objects and may “delete” the scan body during or after the scan. If this occurs, replace Abutment with shorter cuff height and/or place Block Out Spacer(s) onto Abutment to block out shiny metal prior to placing Scan Body.”

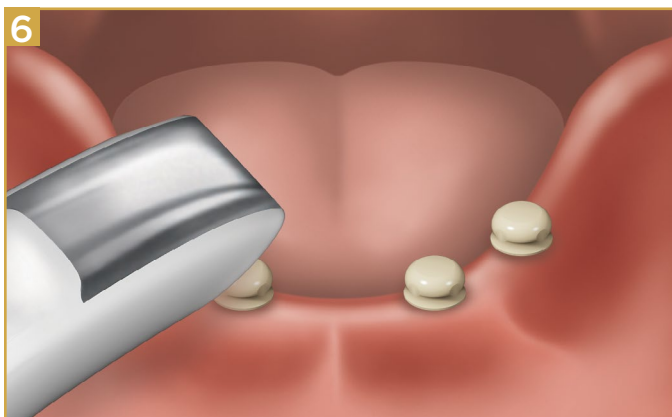

6 TIP When scanning, in addition to capturing the scan bodies, central ridge, and palatal surfaces, be sure to capture as much of the prosthetic border as possible.

DIGITAL RECORD CAPTURE: METHOD 1 (CONTINUED)

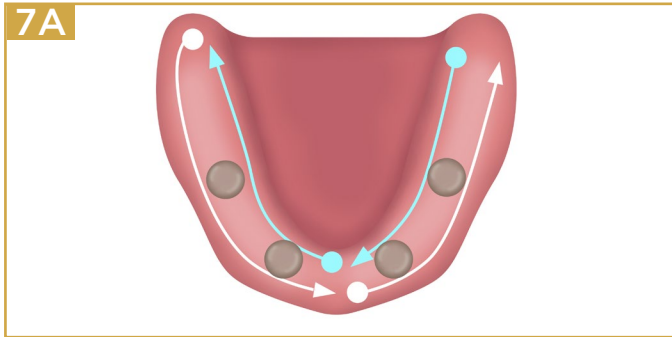

7A SCANNING MANDIBULAR ARCH Scan the lingual side of the ridge, starting from the retromolar pad and continuing to the midline, and then move back towards the retro-molar pad on the buccal surface. Repeat on the patient's other side.

TIP: Instruct the patient to minimize moving the tongue, lips, or cheeks while scanning to minimize double-imaging while scanning. Also, using a slight “bouncing” or up/down technique while scanning may help with challenging cases.

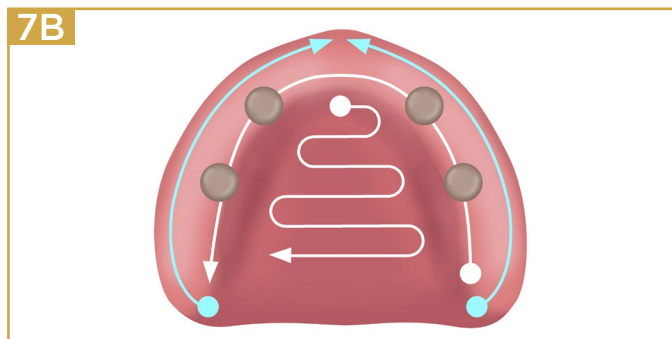

7B SCANNING MAXILLARY ARCH On the maxilla, begin the scan in the patient's posterior region of either side. Scan along the central ridge to the opposing side and then scan the entire palate region. Complete the capture by scanning the buccal surface of the central ridge.

TIP: Consider using removable scanning mode and/or toggle AI features on/off during scan to optimize scanning.

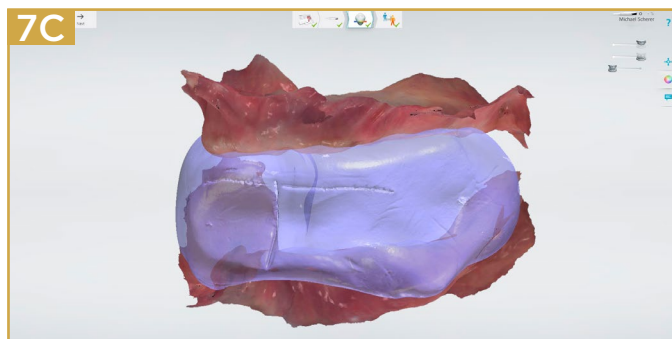

7C OPTIONAL: Scanning the opposing arch is recommended. Additionally, fabricating and scanning occlusion rims or a mush bite can be used to help align the two arches in the design software.

TIP: Post-process all scans prior to dismissing the patient. Evaluate the scan to ensure Scan Bodies and restorative spaces are fully captured, and that there are no missing areas or double images.

DIGITAL RECORD CAPTURE: METHOD 2

REFERENCE DENTURE SCAN IN ADDITION TO INTRAORAL SCANNING WITH LOCATOR® ABUTMENTS AND SCAN BODIES PLACED

This method adds intraoral scans of the patient's relined dentures to the patient's intraoral jaw scans. It is useful in determining jaw relation and providing a design template for the final prosthesis. The two scanning phases are as follows:

1. Scanning the relined denture(s) 360-degrees outside of the mouth.
2. Placing the denture(s) back in the patient's mouth, then capturing the occlusion/bite scan intraorally.

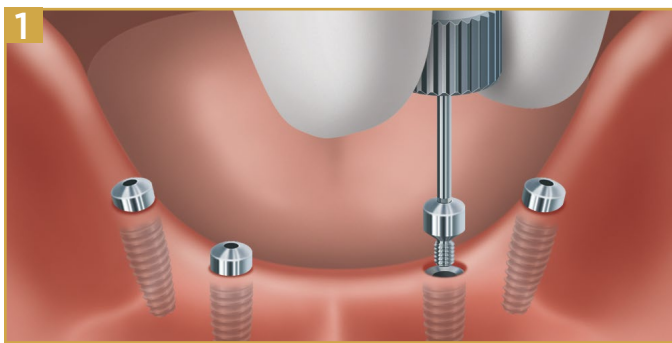

1 If present, remove healing abutments

NOTE: If existing LOCATOR® abutments are already present, inspect them for wear and correct cuff height. If debris is present, clean abutments prior to step 4.

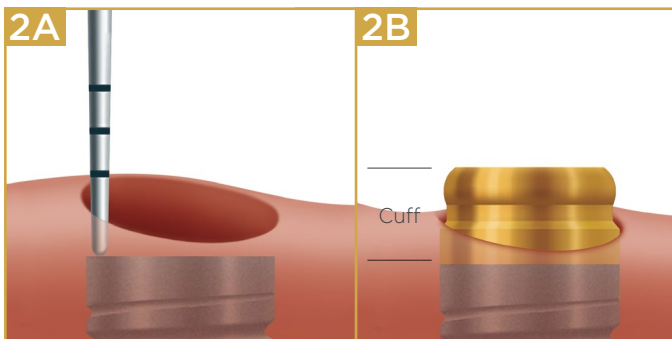

2A-2B Measure tissue height for each implant site and select the corresponding LOCATOR® abutment.

EXAMPLE: If the tissue depth is 2mm, select the 2mm LOCATOR® abutment. Choose the higher number if the measurement is between depths.

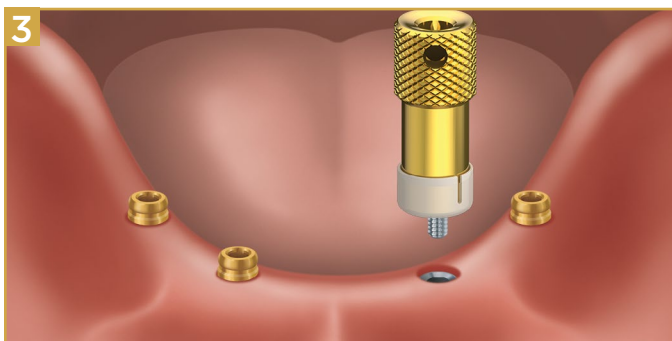

3 Tighten the LOCATOR Abutment into the implant and hand tighten. Radiograph each interface to confirm that the Abutments are fully seated on the implants.

DIGITAL RECORD CAPTURE: METHOD 2 (CONTINUED)

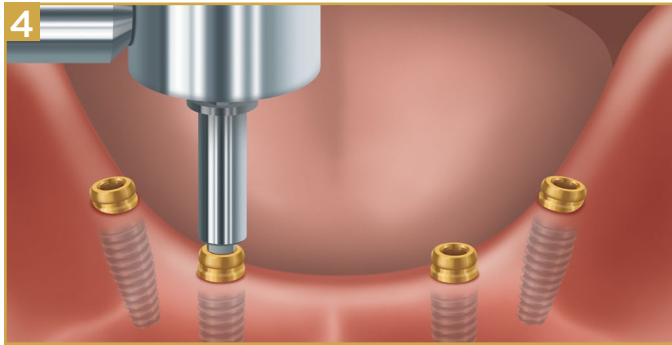

4 Using a torque device and the LOCATOR Driver Insert, torque each LOCATOR Abutment to 30Ncm or tighten to the recommended torque from the implant manufacturer.

NOTE: Implants with $\leq 1.4\text{mm}$ thread require the LOCATOR Abutment be torqued to 20Ncm.

WARNING: Use of higher torque values than recommended could cause a fracture of the LOCATOR Abutment.

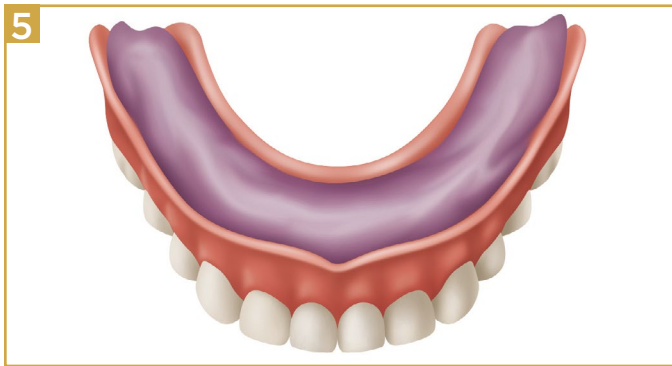

5 Place light body PVS impression material on the intaglio surface of the denture.

NOTE: Adhesive is not required

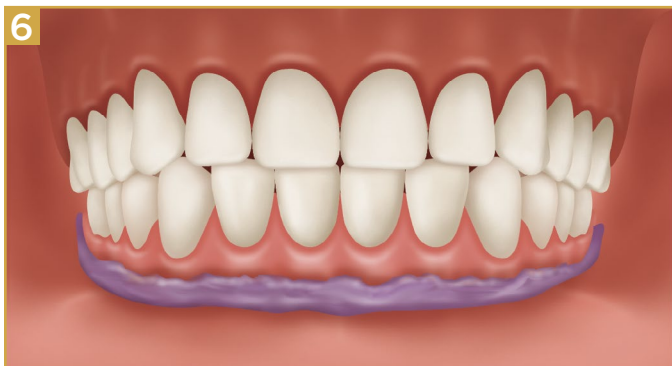

6 Place the denture in the mouth and have the patient close into light occlusion.

Conduct border molding procedure and allow the material to polymerize completely.

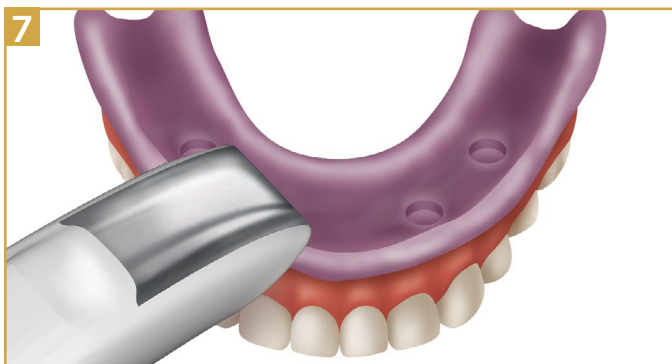

7 Remove the reline impression and scan 360 degrees (scan the entirety of the denture).

DIGITAL RECORD CAPTURE: METHOD 2 (CONTINUED)

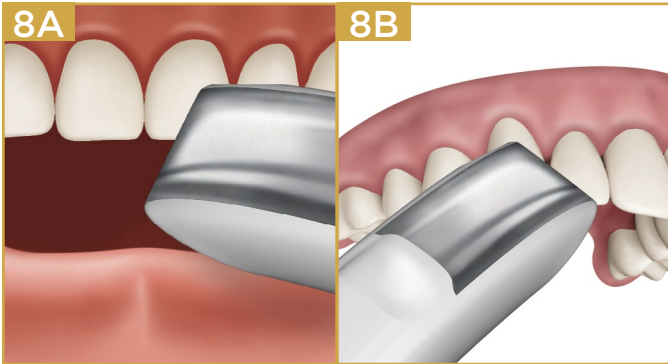

8A-8B Scan the opposing arch intraorally, or extraorally when applicable.

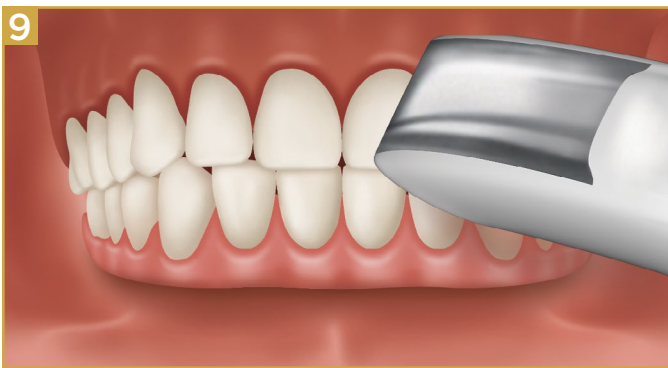

9 Place prostheses back into the mouth, instruct the patient to close, and scan the bite.

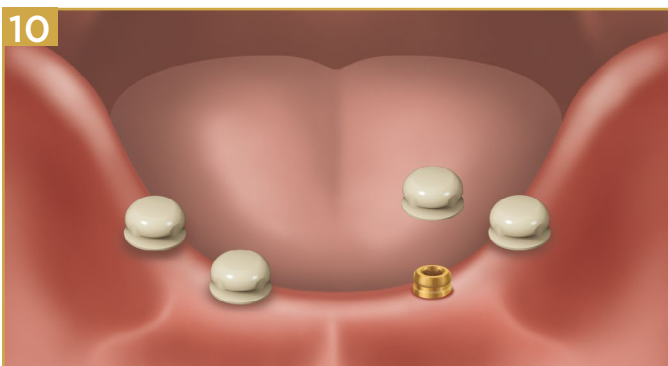

10 Remove the denture(s) and place LOCATOR® scan bodies on the abutments.

DIGITAL RECORD CAPTURE: METHOD 2 (CONTINUED)

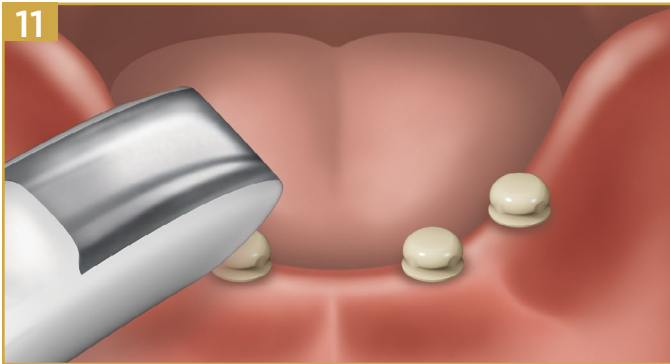

11 In addition to capturing the scan bodies, central ridge, and palatal surfaces, be sure to capture as much of the prosthetic border as possible.

TIP: Some scanners have more difficulty scanning metallic objects and may “delete” the scan body during or after the scan. If this occurs, replace Abutment with shorter cuff height and/or place Block Out Spacer(s) onto Abutment to block out shiny metal prior to placing Scan Body.

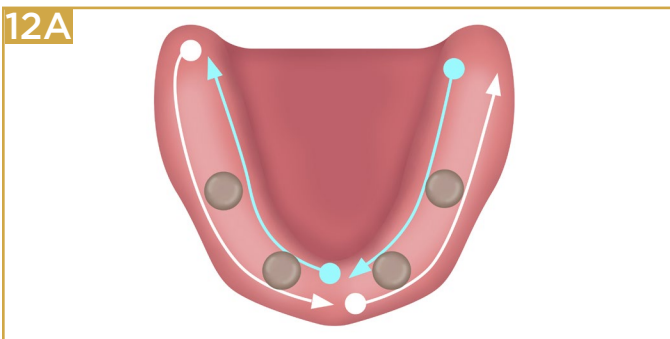

12A SCANNING: On the mandible, scan the lingual side of the ridge, starting from the retro-molar pad and continuing to the midline, and then move back towards the retro-molar pad on the buccal surface. Repeat on the patient’s other side.

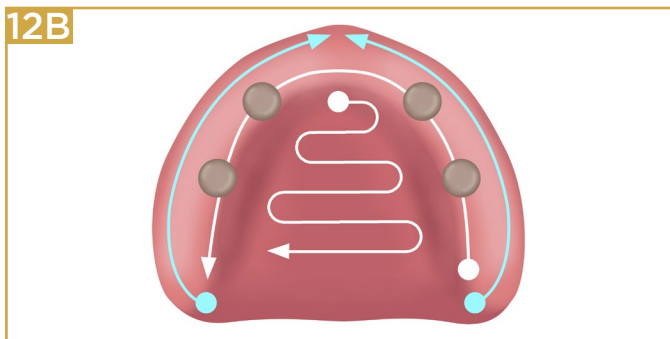

12B SCANNING: On the maxilla, begin the scan in the patient’s posterior region of either side. Scan along the central ridge to the opposing side and then scan the entire palate region. Complete the capture by scanning the buccal surface of the central ridge.

TIP: Post-process all scans prior to dismissing the patient. Evaluate the scan to ensure Scan Bodies and restorative spaces are fully captured, and that there are no missing areas or double images.

DIGITAL RECORD CAPTURE: METHOD 2 (CONTINUED)

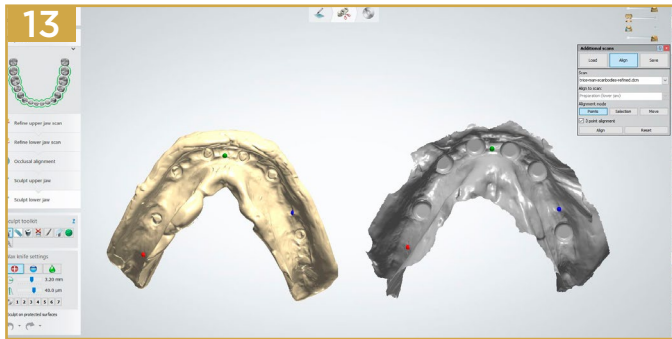

13 To merge the scans together, refer to optional steps 14-16

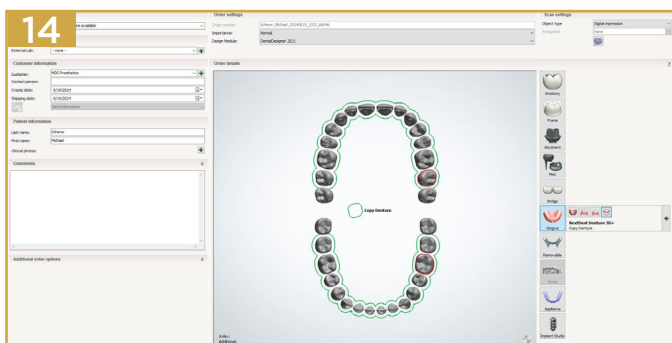

14 OPTIONAL: Create a new order using a dental software, such as exocad or 3shape. Typically a “dummy” indication such as a copy denture or crown to allow for scan alignment is used. Import scans of reference denture into this work order.

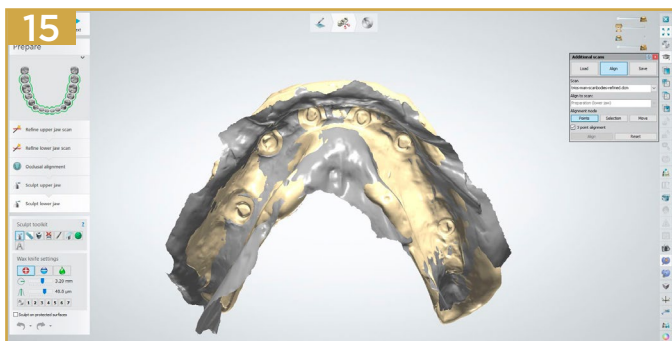

15 OPTIONAL: Use the built in features of the dental software to add an additional scan. Import the scan of the edentulous ridge with scan bodies. Move the two scans so they are in the same visual orientation. Mark points on each scan that have the same corresponding soft tissue anatomical features, such as a retromolar pad or gingiva. Click confirm/align button to align.

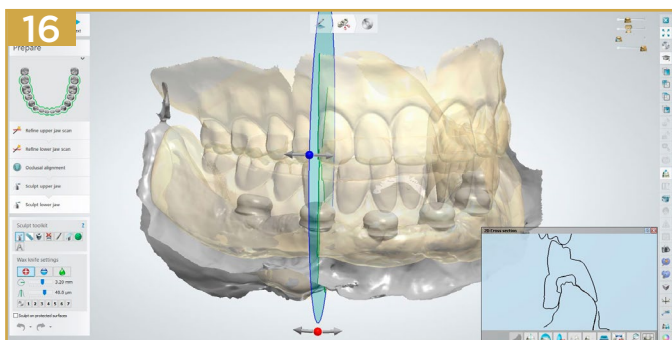

16 OPTIONAL: Inspect the aligned scans using cross section tools to confirm alignment by visually inspecting the outlines of each scan. If a discrepancy between the two scans exists, repeat Step 15 above until they are aligned.

Export aligned scan of edentulous arch with Scan Bodies. Create new case in dental software using aligned scan as the preparation scan to complete design of prosthesis.

DIGITAL RECORD CAPTURE: METHOD 3

POURING AND DIGITIZING ANALOG IMPRESSIONS

If traditional impressions were taken, and the case will have a digitally designed component, use this method to digitize the analog models.

Example situations include the digital fabrication of a supporting framework in a conventionally processed acrylic-resin/PMMA prosthesis, or the fabrication of a digitally produced prosthesis (either monolithic or two piece) from a traditional impression.



1 Attach the lab analogs to the impression copings, and ensure a secure fit.

NOTE: Refer to pages 11-13 for recommended records capture technique.

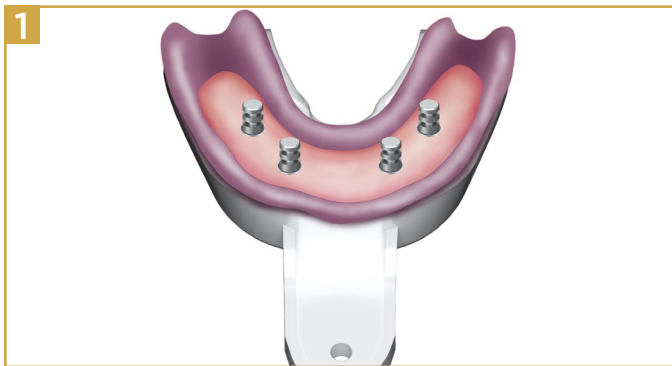

1 OPTIONAL If using a soft tissue mask, apply separator, place material, ensure complete coverage around the implant analogs, and allow it to fully set prior to pouring in the model plaster.



2 Pour dental gypsum, preferably Type IV or V, material to the the impression under vibration to minimize bubbles, and then base and trim the model.

Fabricate the opposing model in the same manner.

DIGITAL RECORD CAPTURE: METHOD 3 (CONTINUED)

3

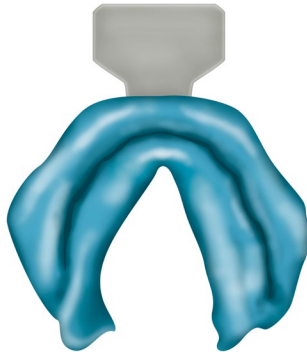

3 If no bite registration was taken, a bite block should be created.

If a bite registration was taken clinically, proceed to step 6.

4

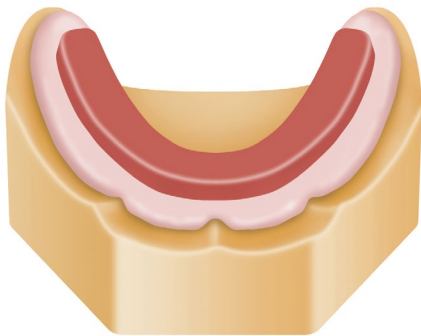

4 To create a bite block, fabricate a baseplate and wax rim on the cast.

OPTIONAL: LOCATOR FIXED Denture Housings with black processing inserts may be processed into the baseplate to provide stabilization during record making and try-in.

5

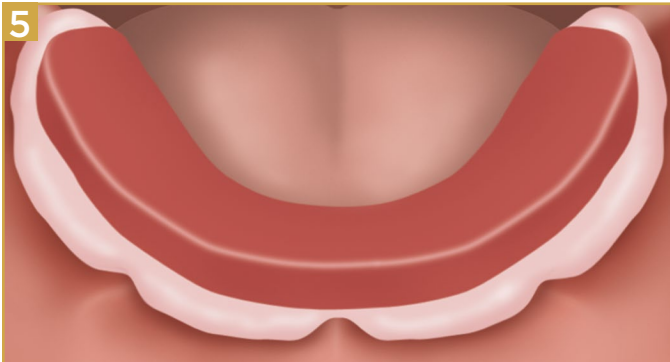

5 Place the bite block into the mouth and record the jaw relation.

6

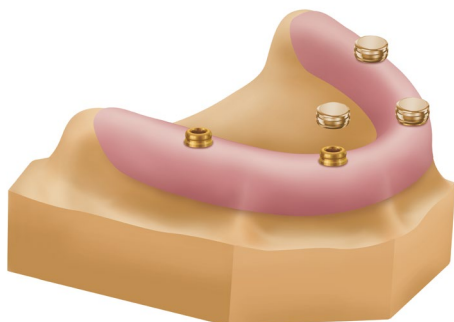

6 Place LOCATOR FIXED® housings on the LOCATOR® abutments and scan the model using either an intraoral or desktop scanner.

TIP: Scan spray is recommended to reduce reflectivity and scanning errors.

DIGITAL RECORD CAPTURE: METHOD 3 (CONTINUED)



7 Scan the opposing model.

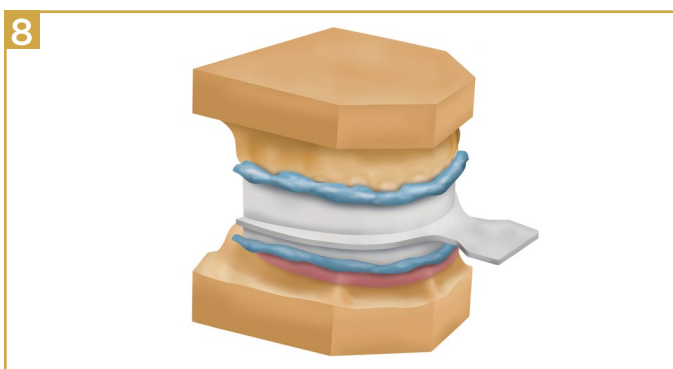

8 Scan both models together using the bite registration or bite block to capture jaw relation.

TIP: Verify that there are no holes or missing sections in any of the scans.

PROSTHETIC FABRICATION

Several factors must be considered when creating the LOCATOR FIXED prosthesis: fabrication method (digital vs. conventional); and structure (monolithic vs. framework/substructure and overlay).

The ideal dental material for use with LOCATOR FIXED prosthetics should be strong enough to resist deformation, fracture, and displacement in function. Monolithic resin/PMMA restorations have been shown to be inherently weaker compared to that of ceramic restorations. To overcome this limitation, a reinforcement framework/substructure component is highly recommended.

Digital workflows can be carried out with a substructure of metal, milled high performance polymer, or nanoceramic covered by a more esthetic material. Additionally, digital manufacture can be accomplished with monolithic materials such as milled high strength-zirconia rated for full arch prostheses, milled/printed PMMA, milled/printed nanoceramics, or other milled/printed base and teeth combinations.

Regardless of the material and fabrication method selected, proper care must be taken to ensure the recommended minimum vertical prosthetic height is met, and the minimum material thicknesses around the housings and maximum material-specific cantilever lengths are maintained. Those requirements are found in the materials matrix found on page 9.

TRADITIONAL ANALOG TECHNIQUE

OPTIONAL

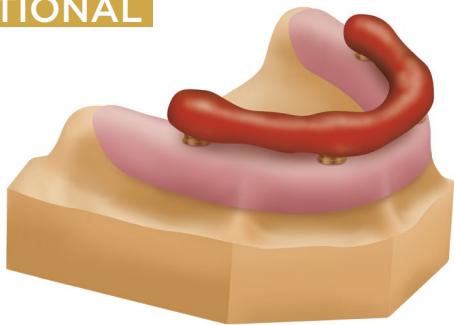

OPTIONAL To ensure the accuracy of plaster casts used to fabricate and/or complete a lab pick-up of the LOCATOR FIXED® housings, create a verification jig prior to the fabrication of the final prosthesis.

1

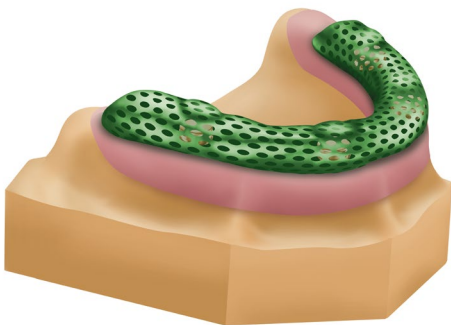

1 CONVENTIONAL WAXED FRAMEWORK: For adequate prosthetic strength, ensure the LOCATOR FIXED housings are covered by the framework, and that there is 1 mm clearance around the housings to accommodate the bonding material.

PROSTHETIC FABRICATION: TRADITIONAL ANALOG TECHNIQUE

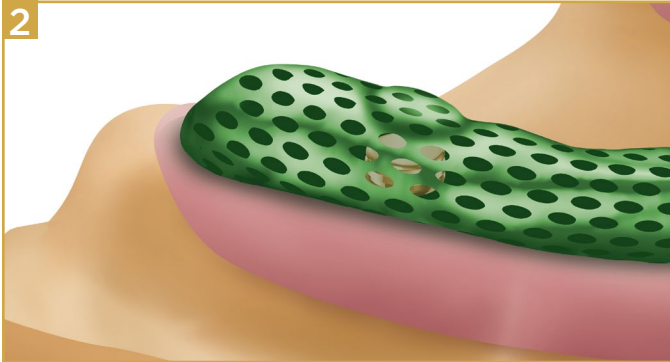

2 Ensure the framework extends to the posterior edge of the cantilever, and that the cantilever does not exceed the A/P spread recommendations outlined in the material matrix on page 9.

Cast and process the framework.

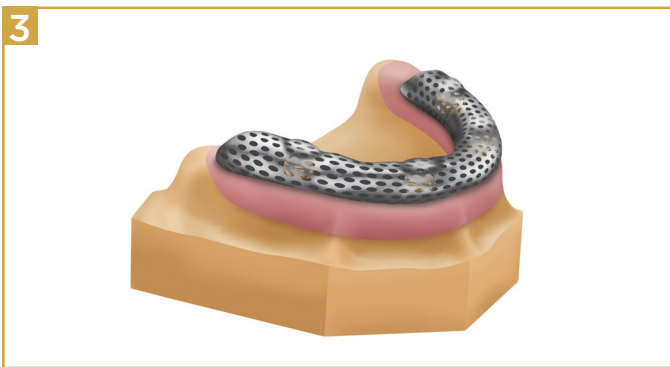

3 With the LOCATOR FIXED® housings and black inserts placed, verify the finished framework on the model to ensure a passive fit and 1mm gap around the housings.

Modify as needed and then conventionally process the acrylic overlay on the framework.

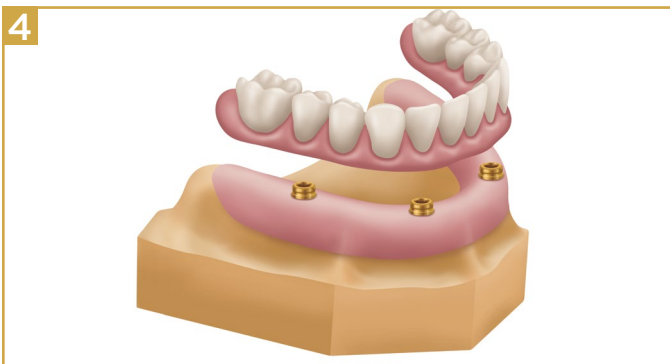

4 Conduct a final fit check of the completed prosthesis on the model and modify as needed.

PROSTHETIC FABRICATION: MIXED WORKFLOW TECHNIQUE (TRADITIONAL IMPRESSIONS/DIGITAL PROSTHETIC DESIGN)



1 DIGITALLY DESIGNED FRAMEWORK: For a digitally designed and manufactured framework, scan the model according to the instructions on pages 22-24.

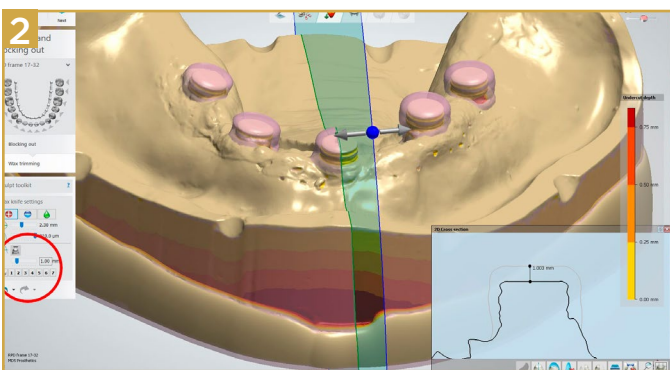

2 For adequate prosthetic strength, design the framework/prosthesis so that LOCATOR FIXED housings are covered and that there is a .5mm gap around them for zirconia or a 1mm gap for all other materials.

NOTE: When scanning models using LOCATOR scan bodies, a 0.5mm space around the housing is automatically created. Zirconia designs do not need any extra space added, however, when using other materials, add 0.5mm of space on top of scan body geometry to achieve the necessary 1mm of total space.

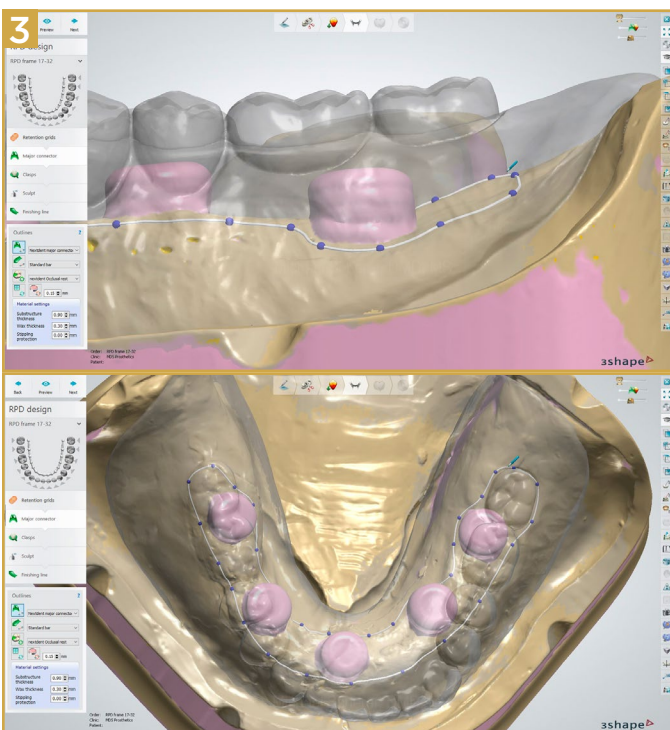

3 Design the framework/substructure to the posterior edge of the cantilever.

The cantilever should not exceed the A/P spread recommendations in the material matrix on page 9.

Export the framework design files and manufacture.

PROSTHETIC FABRICATION: MIXED WORKFLOW TECHNIQUE (TRADITIONAL IMPRESSIONS/DIGITAL PROSTHETIC DESIGN) (CONTINUED)

4

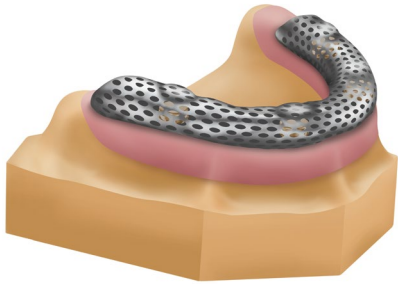

4 With the LOCATOR FIXED® housings and black inserts placed, verify the finished framework on the model to ensure a passive fit and 1mm gap around the housings.

Modify as needed and then conventionally process the acrylic overlay on the framework.

5

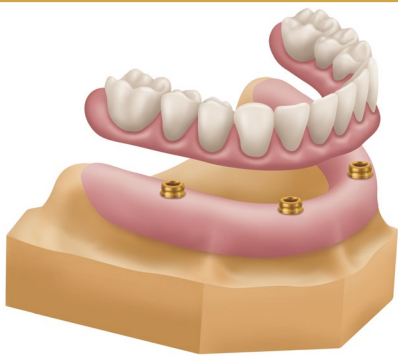

5 Conduct a final fit check of the completed prosthesis on the model, and modify as needed.

PROSTHETIC FABRICATION: DIGITAL TECHNIQUE

DIGITAL TECHNIQUE

Prior to design, ensure that all scans were completed following the steps outlined in the Digital Record Capture sections on pages 14-21.



1 In the design software, align scan(s) of reference denture or model with wax-up/try-in to the scan with the intraoral tissues by selecting common landmarks between them.

TIP: Review steps as outlined on page 21.

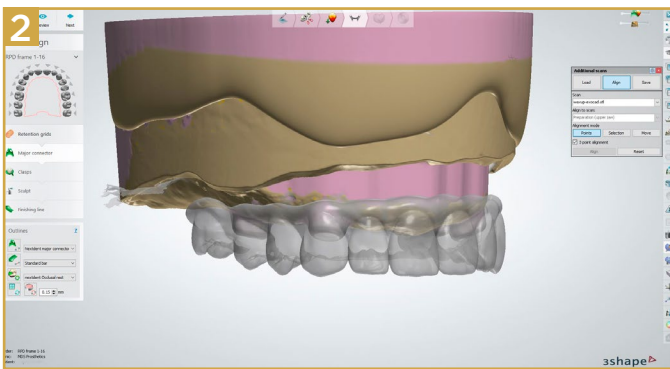

2 With all scans merged, design the prosthesis as either a monolithic or two-piece (overlay on substructure).

If a reference denture was scanned, this can be used as a template for the final prosthesis.

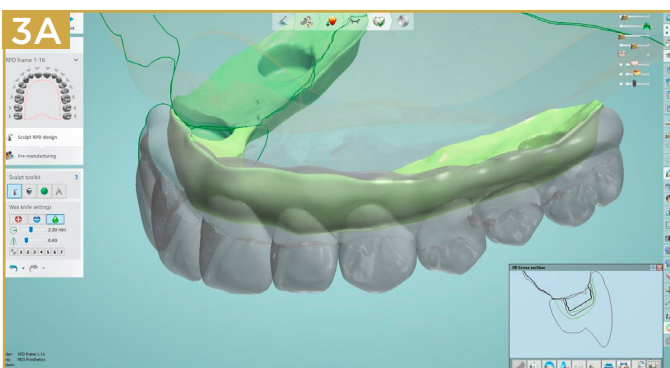

3A TWO PIECE PROSTHESES: Ensure each component meets the manufacturer's recommended minimum material thicknesses, and that the entire prosthesis meets the material-specific requirements referenced in the material matrix on page 9.

PROSTHETIC FABRICATION: DIGITAL TECHNIQUE (CONTINUED)

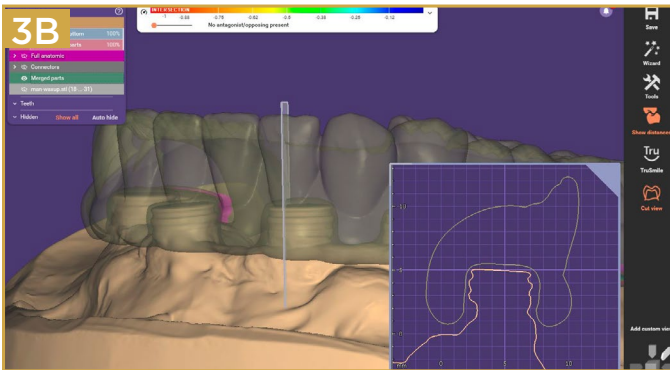

3B MONOLITHIC PROSTHESES: Ensure the prosthesis meets the material-specific requirements referenced in the material matrix on page 9.

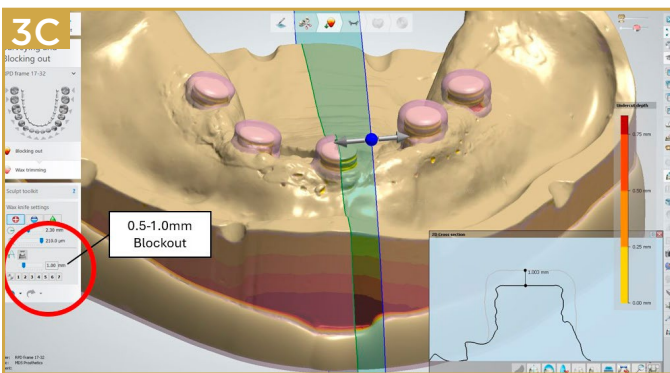

3C If the LOCATOR FIXED® housings will be cemented to zirconia, a cement gap of .5 mm around the Locator housings is recommended.

For all other materials, a gap of 1 mm is recommended.

NOTE: When scanning models using LOCATOR scan bodies, a 0.5mm space around the housing is automatically created. Zirconia designs do not need any extra space added, however, when using other materials, add 0.5mm of space on top of scan body geometry to achieve the necessary 1mm of total space.

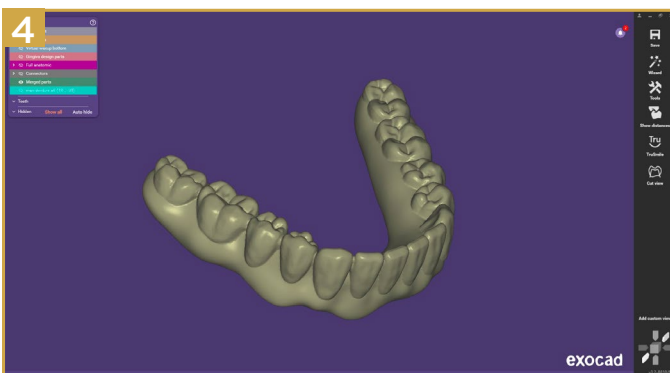

4 With the design complete, print or mill the prosthesis according to the manufacturer's instructions.

If a framework/support structure is utilized, bond all components together following the material manufacturer's instructions prior to the pick-up of the LOCATOR FIXED® housings.

LOCATOR FIXED HOUSING PICK UP

LOCATOR FIXED® housings must be luted/cemented to the prosthesis prior to final insertion. Whether using a chairside or lab (extra oral) pick-up technique, care must be taken to ensure an accurate pick up and complete luting/cementation of the housings.

To ensure a precise fit, the lab (extra oral) technique requires an accurate dental cast or stone model. A verification jig can be used to verify model accuracy. Some laboratories will prefer processing of FIXED Housings in the laboratory when zirconia is chosen as the material for the prosthesis.

A chairside pickup is suitable for immediate conversions and all material options, however, as noted, when cementing to zirconia, moisture control is paramount.

For all material types, placing an undercut in the housing recesses to ensure mechanical retention is highly recommended. The undercut should be made using material appropriate instruments. When fabricating a Zirconia prosthesis, the ideal time to place mechanical undercuts is during the more workable “green-state” of the Zirconia using the LOCATOR CHAIRSIDE® Undercut bur. With any other materials, the ideal time to place mechanical undercuts is when the prosthesis is finalized and prior to returning to the clinician for chairside luting procedures.

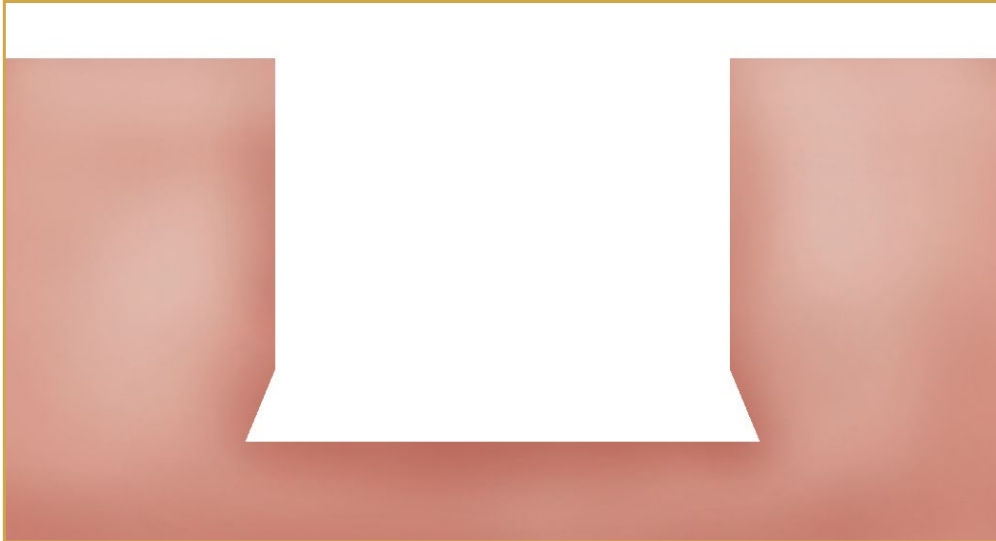

UNDERCUT PROFILE

LOCATOR FIXED HOUSING PICK UP

The below chart shows the proper bonding material and special considerations for each material choice:

Material around housing	Cement/Bonding material recommended and cement gap around housings	Handling and Special Considerations
Zirconia	CEM-EZ (or similar resin-cement) .5mm gap around housings	<ul style="list-style-type: none"> • Green state preparation: Using handpiece, place mechanical undercuts along walls • After sintering and final glazing and prior to luting of housings, air abrade recesses with 27µm aluminum oxide (such as Zest Aluminum Oxide #80042A-M) using maximum 2psi air pressure. Air dry to remove particles • Recommended: apply primer (such as Zest Z-Bond #93410-M), air dry, and cure
Metal (Chrome Cobalt or Titanium)	LOCATOR CHAIRSIDE Attachment Processing Material (or similar composite resin); CEM-EZ (or similar resin-cement) 1mm gap around housings	<ul style="list-style-type: none"> • Using handpiece, place mechanical undercuts along walls • Air abrade recesses with 50µm aluminum oxide (such as Zest Aluminum Oxide #15301-M) using maximum 2psi air pressure. Air dry to remove particles • Optional: apply primer (such as Zest Z-Bond #93410-M), air dry, and cure
Resin/PMMA	LOCATOR CHAIRSIDE Attachment Processing Material (or similar composite resin); auto-polymerizing acrylic resin / PMMA 1mm gap around housings	<ul style="list-style-type: none"> • Using handpiece, place mechanical undercuts along walls • Air abrade recesses with 27µm aluminum oxide (such as Zest Aluminum Oxide #80042A-M) using maximum 2psi air pressure. Air dry to remove particles
High Performance Polymer	LOCATOR CHAIRSIDE Attachment Processing Material (or similar composite resin); CEM-EZ (or similar resin-cement) 1mm gap around housings	<ul style="list-style-type: none"> • Using handpiece, place mechanical undercuts along walls • Air abrade recesses with 27µm aluminum oxide (such as Zest Aluminum Oxide #80042A-M) using maximum 2psi air pressure. Air dry to remove particles
Nano Ceramic	LOCATOR CHAIRSIDE Attachment Processing Material (or similar composite resin); CEM-EZ (or similar resin-cement) 1mm gap around housings	<ul style="list-style-type: none"> • Using handpiece, place mechanical undercuts along walls • Air abrade recesses with 27µm aluminum oxide (such as Zest Aluminum Oxide #80042A-M) using maximum 2psi air pressure. Air dry to remove particles

LOCATOR FIXED HOUSING PICK UP

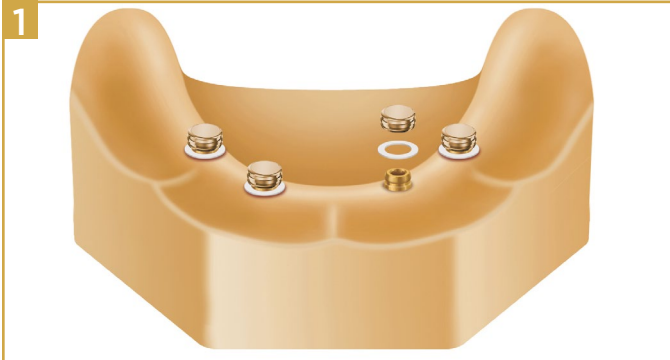

1 Place a Block-out Spacer and LOCATOR FIXED® housing on the LOCATOR® abutments.

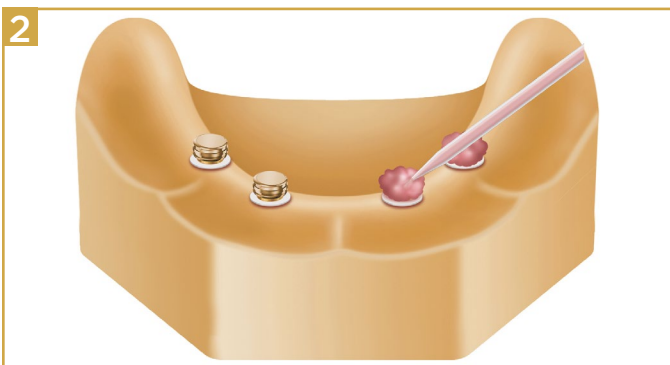

2 Ensure the housings are clean and dry and then apply the appropriate cement/luting material to the housings.

**Refer to the cementation chart on page 32 for specific cement/material combination*

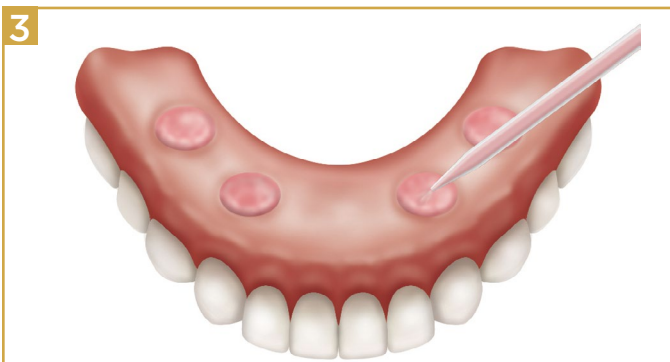

3 Add additional cement/bonding material to the recesses so they are about 2/3rds full.

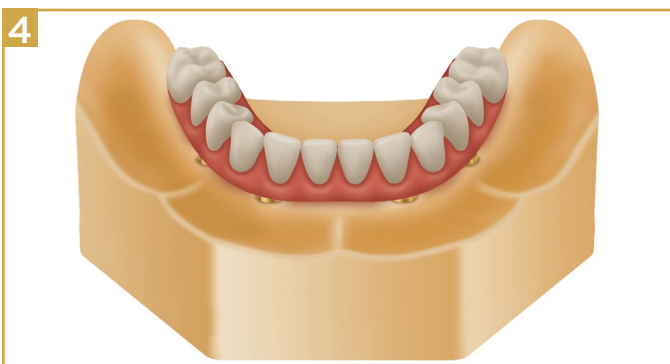

4 Place the prosthesis on the model.

HOUSING PICKUP: LAB PICKUP (CONTINUED)

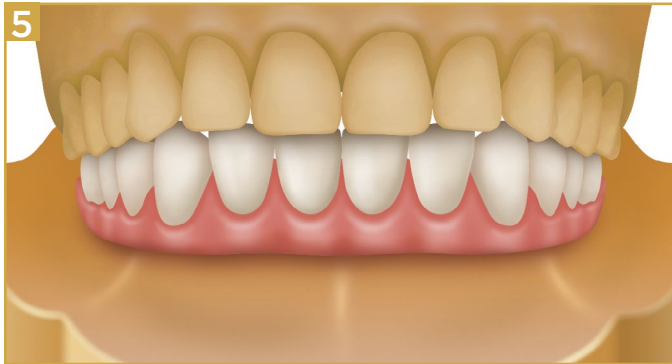

5 Close the model into occlusion and allow the bonding material to cure according to the manufacturer's instructions.

PRO TIP: A bite record can be utilized to assist stabilizing the prosthesis during this step.

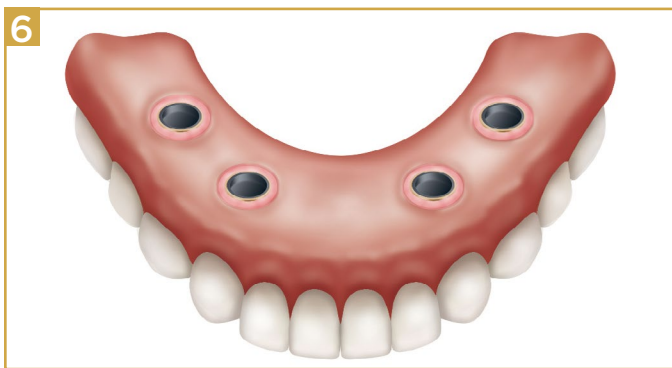

6 Remove the prosthesis. Add more cement/bonding material as necessary to fill any voids.

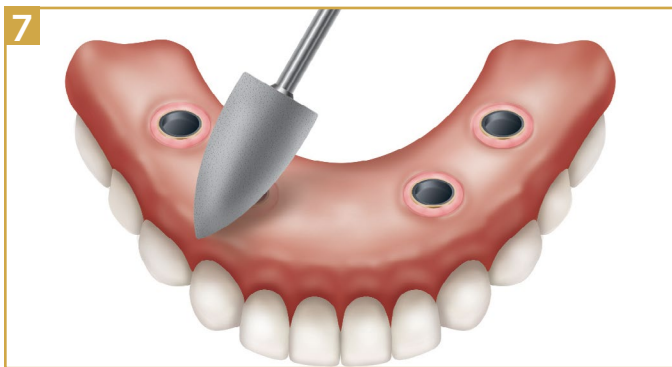

7 Using material-appropriate instruments, polish to final finish and leave the black processing inserts in the housings during polishing procedures to protect the housings.

The final inserts will be placed chairside when the prosthesis is seated in the patient's mouth.

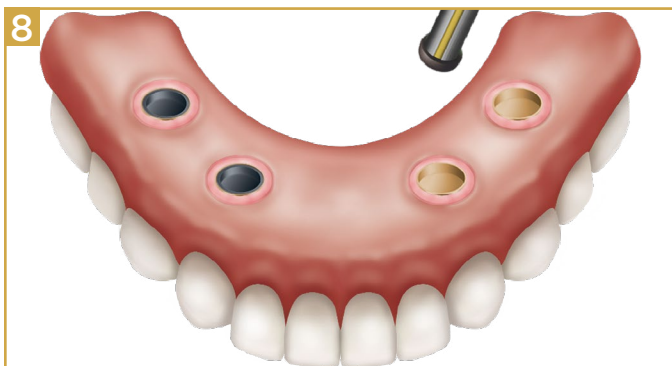

8 Replace black processing inserts if damaged during polishing procedures.

CHAIRSIDE PICKUP-NEW PROSTHESIS OR IMMEDIATE CONVERSION

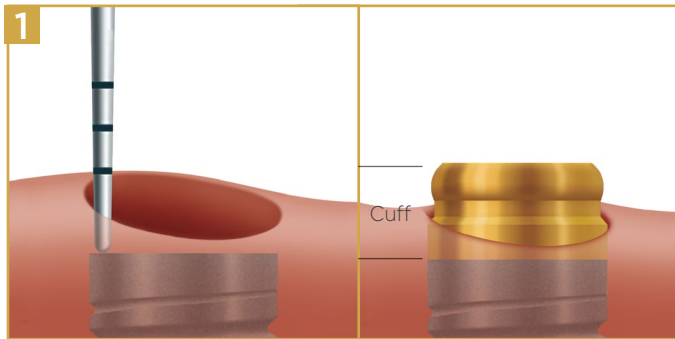

1 If existing LOCATOR® abutments are already present, inspect them for wear and correct cuff height. If debris is present, clean abutments prior to step 2.

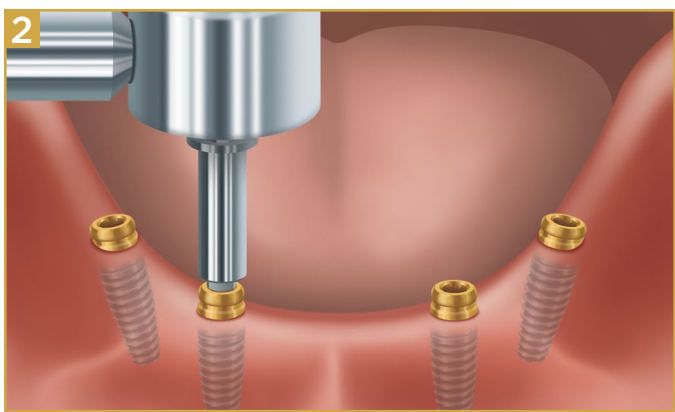

2 Using a torque device and the LOCATOR Driver Insert, torque each LOCATOR® abutment to 30Ncm or tighten to the recommended torque from the implant manufacturer.

NOTE: Implants with $\leq 1.4\text{mm}$ thread require the LOCATOR Abutment be torqued to 20Ncm.

WARNING: Use of higher torque values than recommended could cause a fracture of the LOCATOR Abutment.

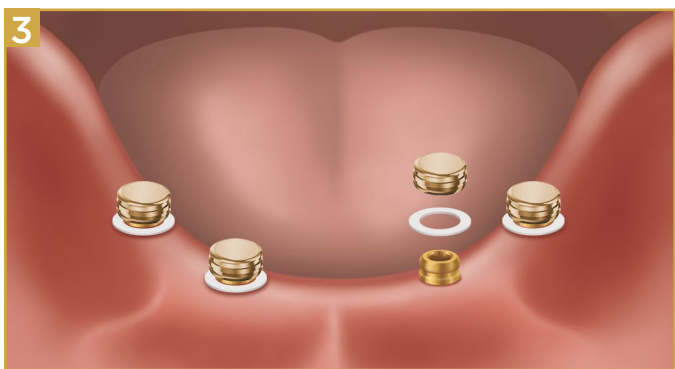

3 Place a Block-out Spacer and LOCATOR FIXED® housing with black insert on the LOCATOR abutments.



4 If converting a denture, or picking up a prosthesis that does not have housing recesses included, the LOCATOR housing positions must first be transferred to the prosthesis.

If picking up a prosthesis with existing housing cutouts, skip to step 9.

CHAIRSIDE PICKUP-NEW PROSTHESIS OR IMMEDIATE CONVERSION (CONTINUED)

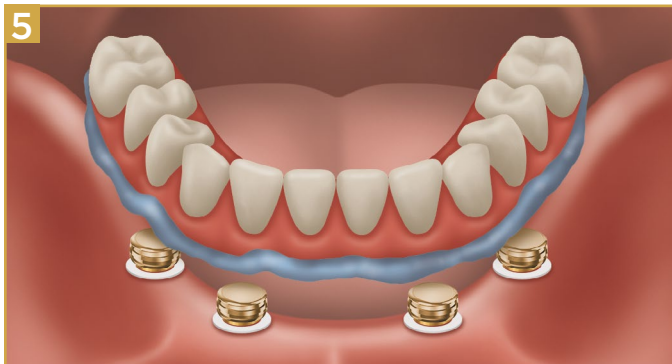

5 Apply fit-check marking paste or fast set impression material to the intaglio surface of the prosthesis and press down on the denture housings to capture their position.

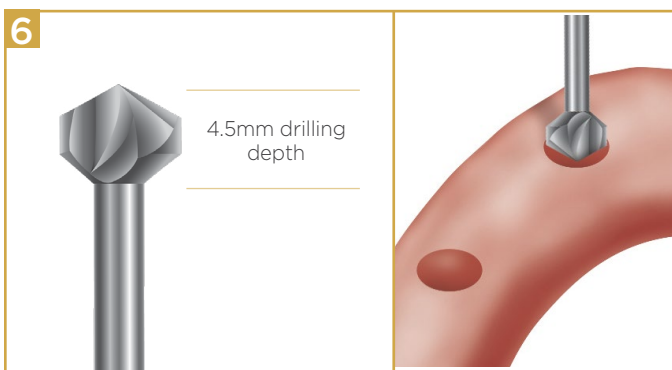

6 Relieve the marked areas with the LOCATOR CHAIRSIDE® Recess Bur (09576). Zest recommends using slight pressure and a small rocking motion to get the tip of the Bur started, followed by a straight downward motion to create the desired recess site. This efficient Bur has distinct depth landmarks which indicate where to stop when drilling for the Denture Housing.

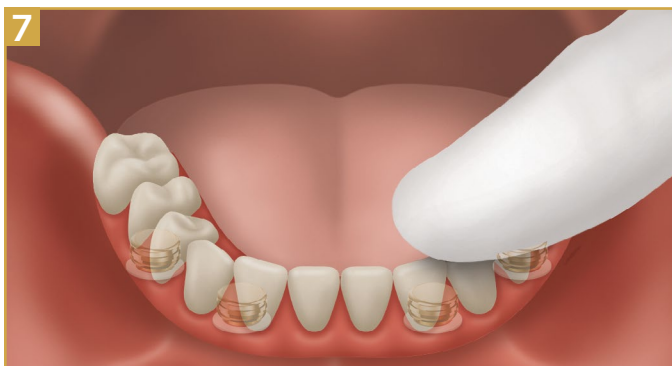

7 Re-check the prosthesis over the housings to test for passive fit and use the acrylic cutting bur to clear material as needed to achieve passive fit.

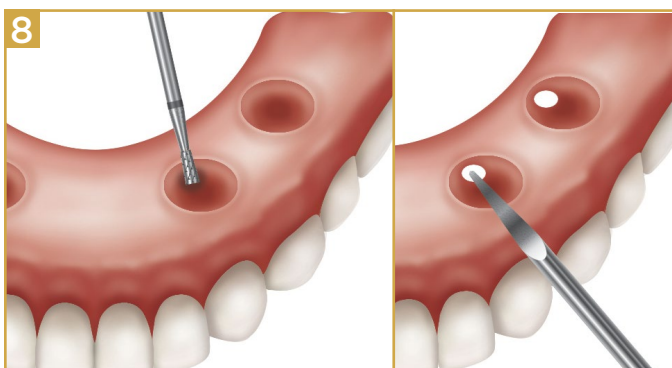

8 Use the LOCATOR CHAIRSIDE® Undercut Bur (09577), to create an undercut around the circumference of the recesses for mechanical retention. Creating a sufficient undercut is required to create the necessary mechanical retention when using LOCATOR CHAIRSIDE® Attachment Processing Material with LOCATOR FIXED cases.

OPTIONAL: Cut lingual/palatal vent windows in the overdenture with the LOCATOR CHAIRSIDE® Vent Bur to visualize full seating and for excess material to vent.

CHAIRSIDE PICKUP-NEW PROSTHESIS OR IMMEDIATE CONVERSION (CONTINUED)

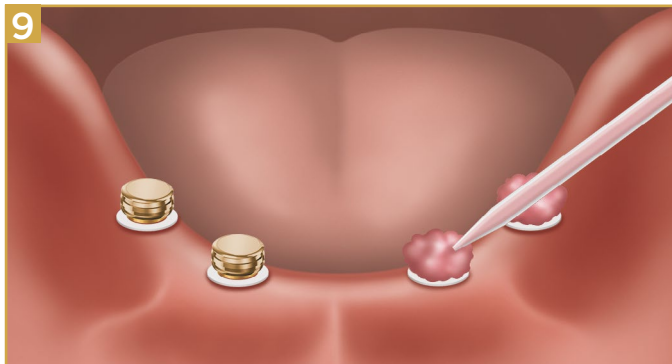

9 Ensure the housings are completely clean and dry and then apply the appropriate cement/bonding material to housings.

**Refer to the cementation chart on page 32 for specific cement/material combinations*

TIP: In areas of vertical defect Utilize Zest's Block out material prior to applying cement/bonding material to prevent Locking in the prosthesis.

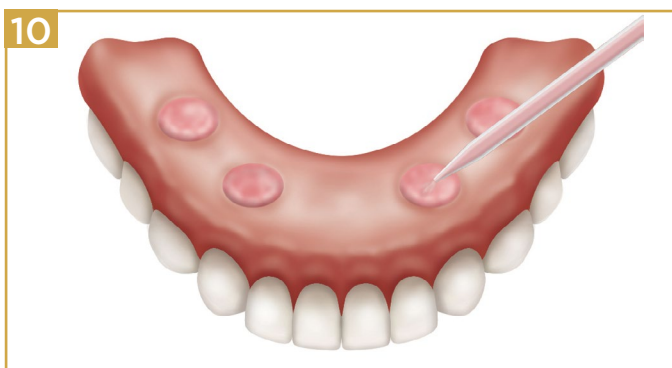

10 Add additional cement/luting material to the recesses so they are about 2/3rds full.

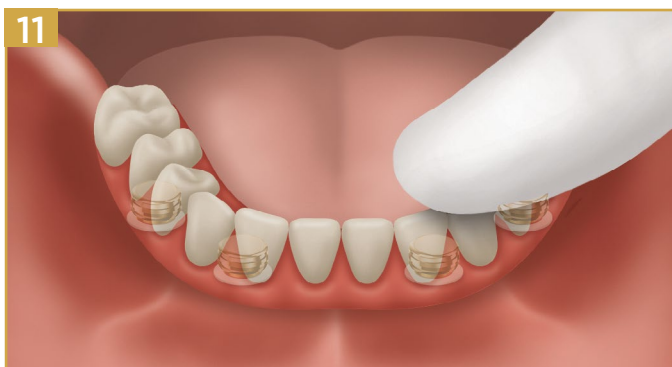

11 Seat the prosthesis with light finger pressure.

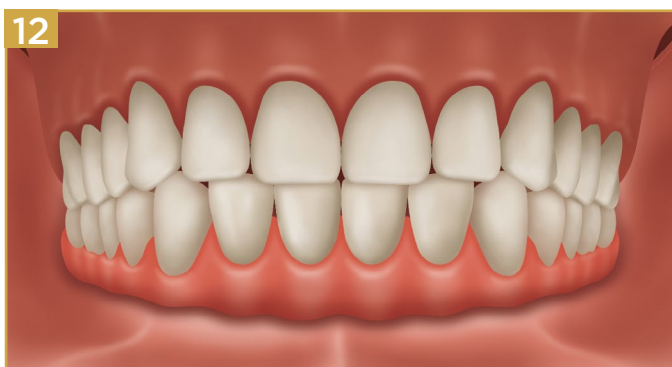

12 Have the patient close gently into occlusion. Allow the material to set and then remove the prosthesis.

NOTE: Excessive occlusal pressure during the setting time may cause tissue recoil against the overdenture base and could contribute to dislodging and premature wear of the Insert

NOTE: If using LOCATOR CHAIRSIDE APM®, light cure to ensure the position of the housings.

CHAIRSIDE PICKUP-NEW PROSTHESIS OR IMMEDIATE CONVERSION (CONTINUED)

13A

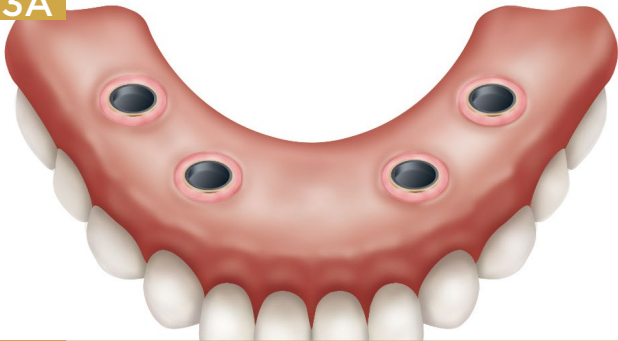

13A Inspect the area around the housings. Fill in any remaining voids with the cement/luting material used to capture the housings and cure according to the manufacturer's instruction.

13B

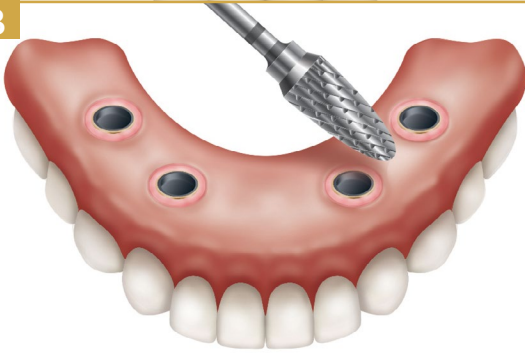

13B If converting an immediate denture, use acrylic cutting and polishing tools to trim flange/borders and remove palate if needed.

Trim cantilever to 2mm beyond the posterior-most abutments to allow sufficient room for the prosthesis removal tool to engage with the prosthesis.

14

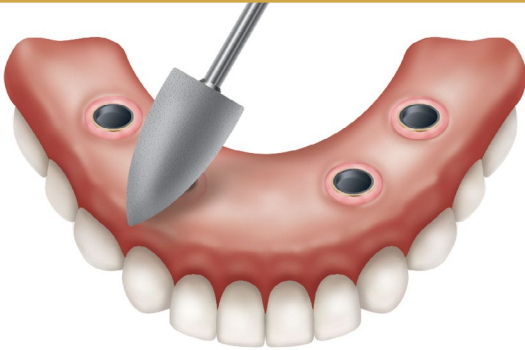

14 Use material appropriate grinding and polishing tools to remove any excess cement/bonding material and smooth out any rough surfaces.

15

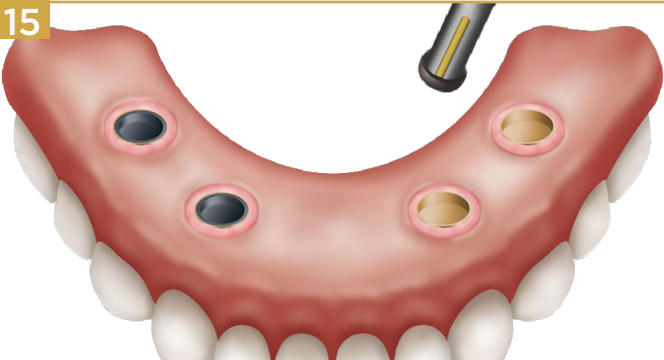

15 Using the Core Tool, remove the black processing inserts.

CHAIRSIDE PICKUP-NEW PROSTHESIS OR IMMEDIATE CONVERSION (CONTINUED)

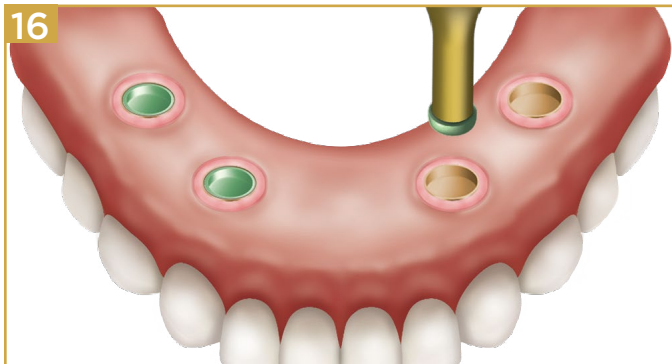

16 Using the LOCATOR Enhanced Core Tool, insert the recommended inserts according to the patterns in the below images:

LOCATOR FIXED RETENTION INSERT SELECTION

Retention Insert Selection: INSERTS ARE FOR SINGLE USE ONLY

- Inserts are available in Green, Tan and Blue



- Green: Four Unit Positions (4 Implants)
 - Tan: Anterior/Posterior Positions (5+ implants)
 - Blue: Mid Arch Positions (5+ implants)
- Inserts are SINGLE USE ONLY and require replacement after any clinical or laboratory use. Reusing Fixed Retention Inserts will result in significant loss of retention and possible dislodgement.
 - Abutment cavities should be cleaned out with a soft bristled brush and air every time the prosthesis is removed.

IDEAL IMPLANT DISTRIBUTION

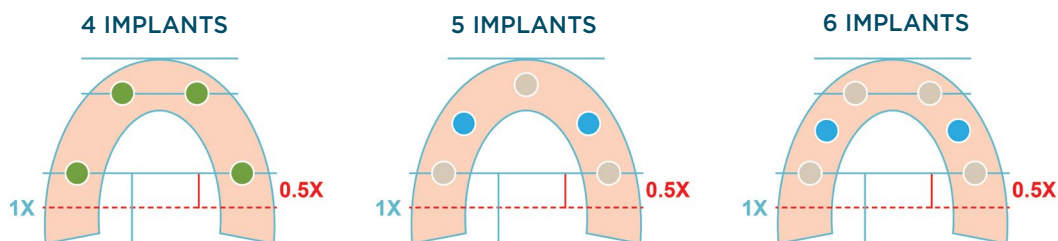

For more than 6 Implants: Use Tan inserts in the most anterior/posterior positions in each quadrant. Use Blue Inserts in the mid arch positions.

NON IDEAL IMPLANT DISTRIBUTION

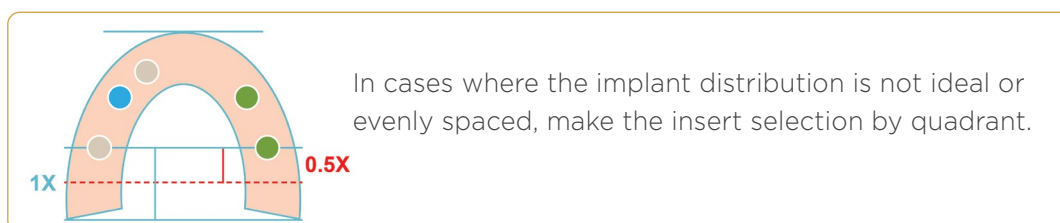

PROSTHESIS SEATING AND REMOVAL

LOCATOR FIXED® SEATING AND REMOVAL TOOL

The LOCATOR FIXED Seating and Removal Tool includes the Tool, Seating Tip Assembly, Tip with Hook Assembly, Removal Tip with Threaded Adapter, Wire and Lever Wrench, and a Tip Wrench. The Tool is used for seating and removing the prosthesis retained by the LOCATOR FIXED Attachment System. The Tool works by generating the required force to engage and disengage the Retention Inserts from the LOCATOR Abutments.

Seating and Removal Tool



Seating Tip Assembly



Tip with Hook Assembly



Removal Tip with Threaded Adapter



Tip Wrench



Wire and Lever Wrench



PROSTHESIS SEATING AND REMOVAL (CONTINUED)

SEATING

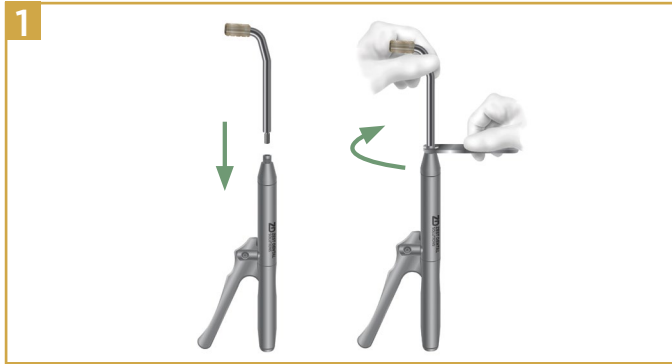

1 Screw and tighten the Seating Tip clockwise onto the tool.

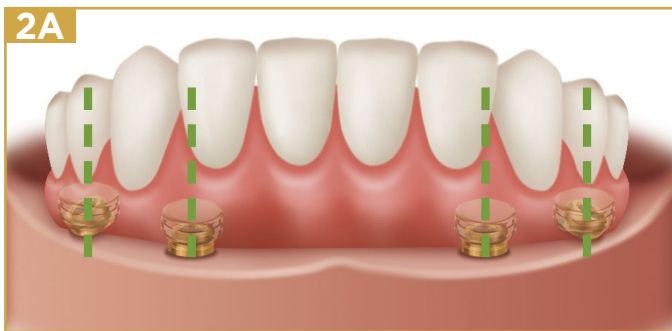

2A Place the prosthesis with the appropriate Retention Insert over the LOCATOR FIXED Abutments.

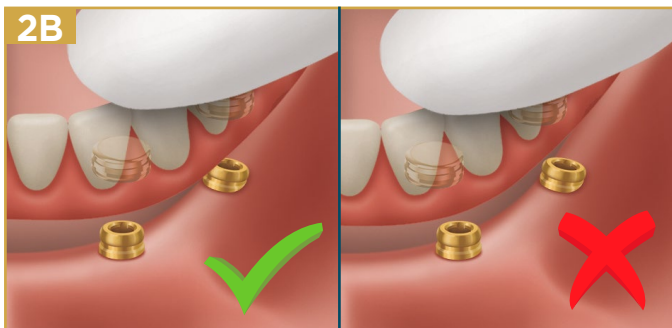

2B Failure to ensure that the Retention Inserts are aligned with the LOCATOR FIXED Abutments can result in damage to the inserts, housing or prosthesis. Press firmly around the arch to seat the prosthesis. An audible click may be heard and confirms the seat.

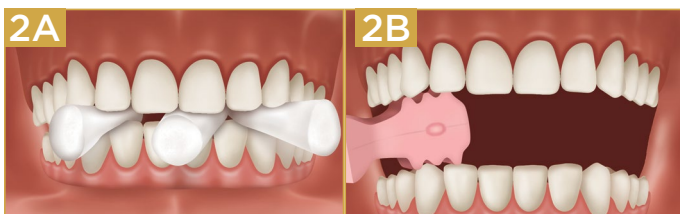

2A-2B OPTIONAL: Patient may also bite on an aligner chewy or cotton roll to facilitate seating the prosthesis.

PROSTHESIS SEATING AND REMOVAL (CONTINUED)

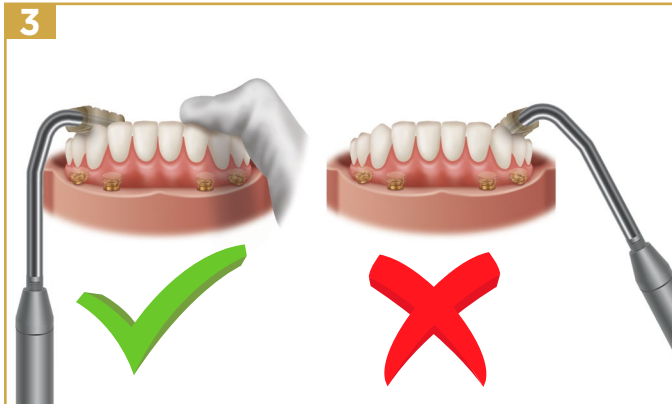

3 Hold Tool perpendicular to the occlusal plane applying pressure to the prosthesis. Holding it at an angle will not provide the needed amount of force to fully seat the Retention Inserts.

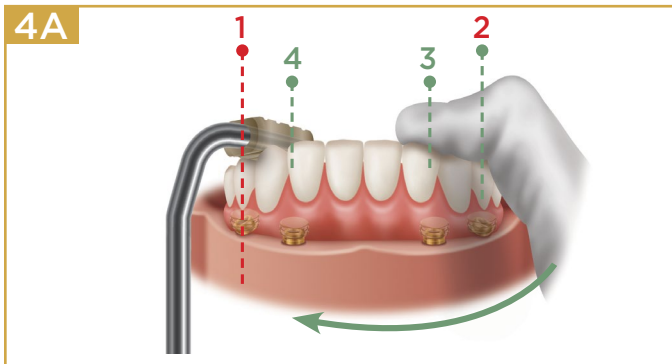

4A Start with the most posterior Abutment on one side. Hold the tool perpendicular to the occlusal plane, pull firmly on the tool to apply pressure against the prosthesis, hold the other side of the prosthesis in place then activate the tool **THREE TIMES** over the Abutment.

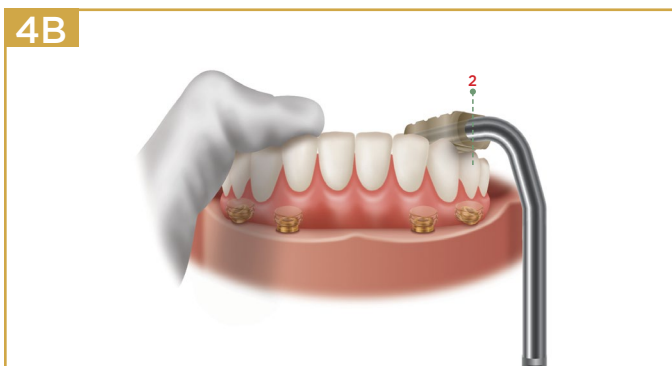

4B Move to the other most posterior Abutment. Hold the tool perpendicular to the occlusal plane, pull firmly on the tool to apply pressure against the prosthesis, hold the other side of the prosthesis in place then activate the tool **THREE TIMES** over the Abutment.

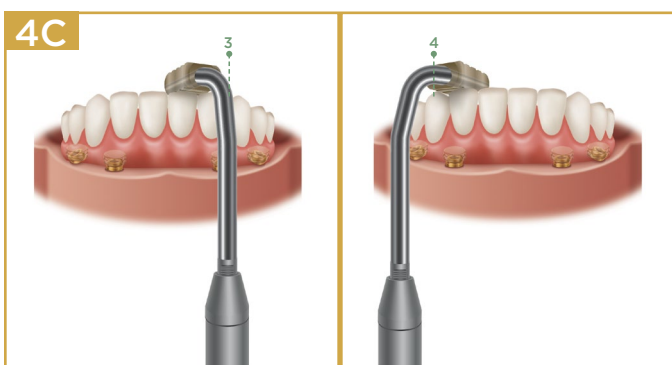

4C Continue anteriorly around the arch. Activate the tool **THREE TIMES** over each Abutment location until all Abutments have been seated.

PROSTHESIS SEATING AND REMOVAL (CONTINUED)



4 **TIP:** Take a radiograph to confirm the prosthesis is fully seated.

PROSTHESIS SEATING AND REMOVAL (CONTINUED)

REMOVAL



1 Attach the Removal Tip to the Threaded Adapter by guiding the pin into the channel and locking it into position. Screw and tighten the Removal Tip clockwise onto the Tool.

TIP: If the Removal Loop is unable to engage the cantilever, unthread the wire using the Wire and Lever Wrench. Thread the wire under the prosthesis and then re-attach the wire to the removal tool using the Wire and Lever Wrench. With the tool now engaging the prosthesis, proceed to steps 2A and B.

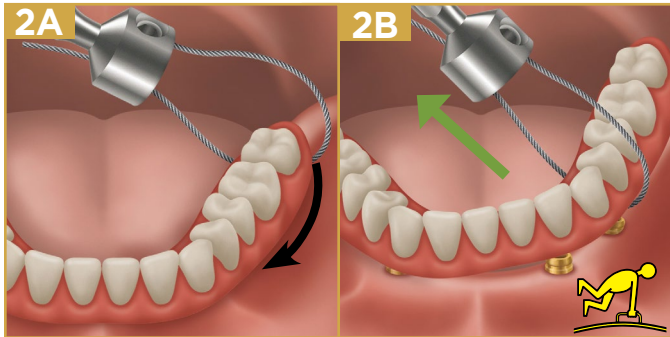

2AB Engage the Removal Loop of the Tool around the distal extension of the prosthesis engaging the intaglio surface. Secure the Removal Loop in position and apply tension on the Tool to ensure that it has a firm grip on the prosthesis. Prior to activation, hold the Tool as perpendicular to the occlusal plane as possible.

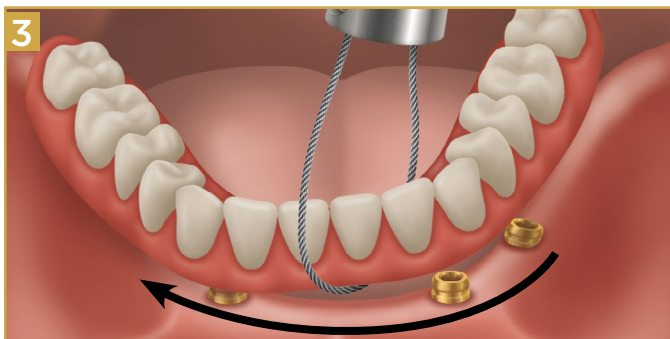

3 Pull on the Tool so that the Removal Loop is taut and activate the Tool handle until the Retention Inserts disengage from the Abutments.

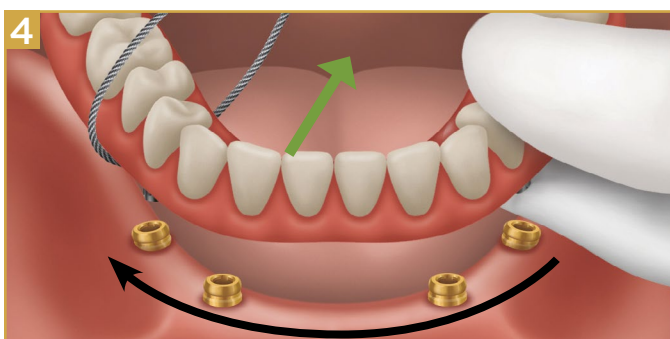

4 Repeat the procedure by moving anteriorly until all Retention Inserts are disengaged. **NOTE:** Hold the prosthesis when disengaging the final Abutments as the prosthesis can spring off the Abutments.

TIP: The tip with Hook Assembly may also be used to remove the prosthesis. When using the Hook Assembly, follow the same posterior to anterior path when disengaging the Abutments.

AFTER-CARE

To maintain the LOCATOR® Abutments and LOCATOR FIXED® restoration, it is critical that clinicians and patients perform routine maintenance on the LOCATOR FIXED® Insert, the Denture Housing and the LOCATOR Abutment. It is also important that patients understand the proper hygiene routines that should be performed at home.

The following are guidelines to consider:

Maintaining proper hygiene is vital to the success of a restoration, helping it last longer and function properly. Similar to natural teeth, dental plaque will also form on the surface of a restoration. If the plaque is not removed, it will continue to accumulate. The prosthesis and space between the tissue and the prosthesis must be thoroughly cleaned each day to prevent plaque build-up.

Dental hygiene tools such as water flossers, floss threaders and Zest Regal Go (Part Number: 90-00239-M) are options to be recommended to patients with LOCATOR FIXED®.



The patient should be scheduled for a recall every six months or once yearly (at the minimum) maintenance and hygiene appointments. At these appointments, the inserts should be replaced each time the prosthesis is removed. Additionally, LOCATOR abutments should be checked and replaced if wear, accumulation of biofilm, or any other issue that may affect the retention and fit of the prosthesis is observed.

ADDITIONAL NOTES OF CAUTION

Failure of the patient to follow oral hygiene protocols and appropriately care for the restoration may also result in inflamed tissue around the implant, leading to the development of peri-implantitis. Throughout time, peri-implantitis may cause the implant to become mobile and fail.

Please ask patients to consider the following when caring for their restorations: Avoid using abrasive toothpaste to clean the restoration. The coarse particles in the toothpaste may scratch the surfaces of the restoration, enhancing the potential for plaque accumulation. Oral rinse such as Listerine® mouthwash can be used safely without any negative effect on the Abutments or Replacement Insert.

PRESCRIPTION WRITING TIPS:

The unique attributes of LOCATOR FIXED allow for final prostheses that require less prosthetic height than their traditional screw retained counterparts. This often allows for greater material options to be considered for every situation.

To give your laboratory the best guidance for manufacturing a LOCATOR FIXED prosthesis, it is recommended to utilize the materials matrix on page 9 and the cementation chart on page 32 when filling out the prescription form.

Based on available restorative space, indicate the preferred material choice on the prescription form, and then, using the material matrix, specify material-specific design requirements such as cantilever length and minimum material thickness around the housings.

If the laboratory will also be cementing the housings to the prosthesis, use the cementation chart on page 32 to provide material-specific guidance on cement type, cement gap around the housings, and instructions to properly prepare the surfaces for cementation.

Additionally, it is important to instruct the laboratory that LOCATOR FIXED definitive prostheses should be designed in the same way their screw-retained counterparts are designed. This means that flanges and ridge laps should be avoided, intaglio surfaces should be hygienic (flat or convex), and the housing recesses should have undercuts placed in them.

TROUBLESHOOTING GUIDE

TROUBLESHOOTING GUIDE

ISSUE: The prosthesis will not fully seat.

SOLUTION: First, inspect for any damage to the inserts and/or housings. If damage to the inserts is identified, replace the inserts and re-attempt the seating. If damage to the housings is identified, remove the housings and redo the housing pickup. Ask the patient to bite on an aligner chewie or cotton roll to seat if still having trouble.

ISSUE: Prosthesis movement is detected after seating is completed.

SOLUTION: Confirm the prosthesis is fully seated by taking an x-ray or checking the bite before and after the seating. If all inserts cannot be seated, remove the housings and redo the housing pickup chairside. If there is an uneven distribution of inserts, replace the tan and blue inserts with green inserts on that quadrant.

PRECAUTION: Avoid defaulting to all green inserts on 5+ implant cases if possible as this can make the prosthesis overly difficult to seat and remove.

ISSUE: Patient is overpowering the inserts and dislodging the prosthesis due to non-uniform implant placement.

SOLUTION: Replace the inserts that are dislodging with the next tighter insert. Replace blue with tan, and tan with green until the patient no longer overpowers the inserts.

PRECAUTION: Avoid defaulting to all green inserts on 5+ implant cases if possible as this can make the prosthesis overly difficult to seat and remove.

ISSUE: Insufficient cantilever exists for the removal tool to engage with the cantilever.

SOLUTION: The Seating and Removal tool can be used even when there is no cantilever to engage. Unthread the wire using the Wire and Lever Wrench, thread the wire under the posterior-most section of the prosthesis, and reattach the wire to the removal tool. Proceed to use the removal tool as outlined on page 44.

VISIT OUR WEBSITE AT
WWW.ZESTDENT.COM
TO PLACE ORDERS ONLINE
24 HOURS A DAY 7 DAYS A WEEK



ZEST DENTAL SOLUTIONS
2875 LOKER AVENUE EAST
CARLSBAD, CA 92010
USA

TEL: 1.855.866.LODI (5934)
FAX: 760.743.7975
EMAIL: SALES@ZESTDENT.COM
WWW.ZESTDENT.COM